

Caution Please read the **Safety Manual** carefully before you start with assembling!

C0156 *Ultra Extreme Climbing Pyramid with Bridge, Modular Slide and Pool L*
To build this model you need: 6x 31002 + 11010 + 10010 + 11670 + 90913

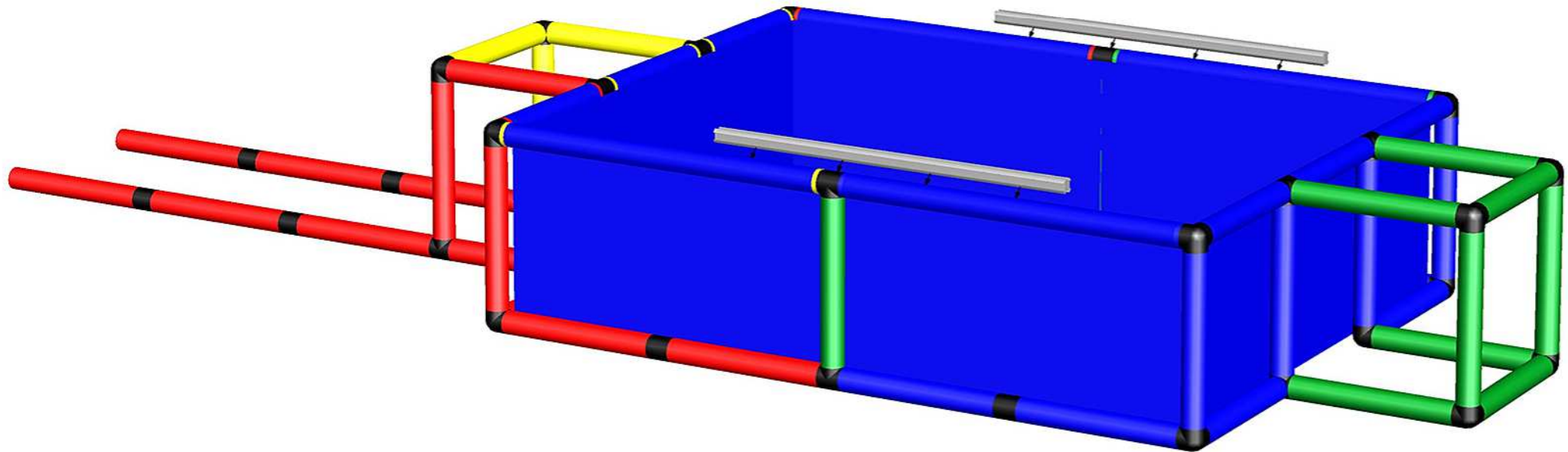

Please read the **Safety Manual** carefully before you start with assembling!

C0156 *Ultra Extreme Climbing Pyramid with Bridge, Modular Slide and Pool L*
To build this model you need: 6x 31002 + 11010 + 10010 + 11670 + 90913

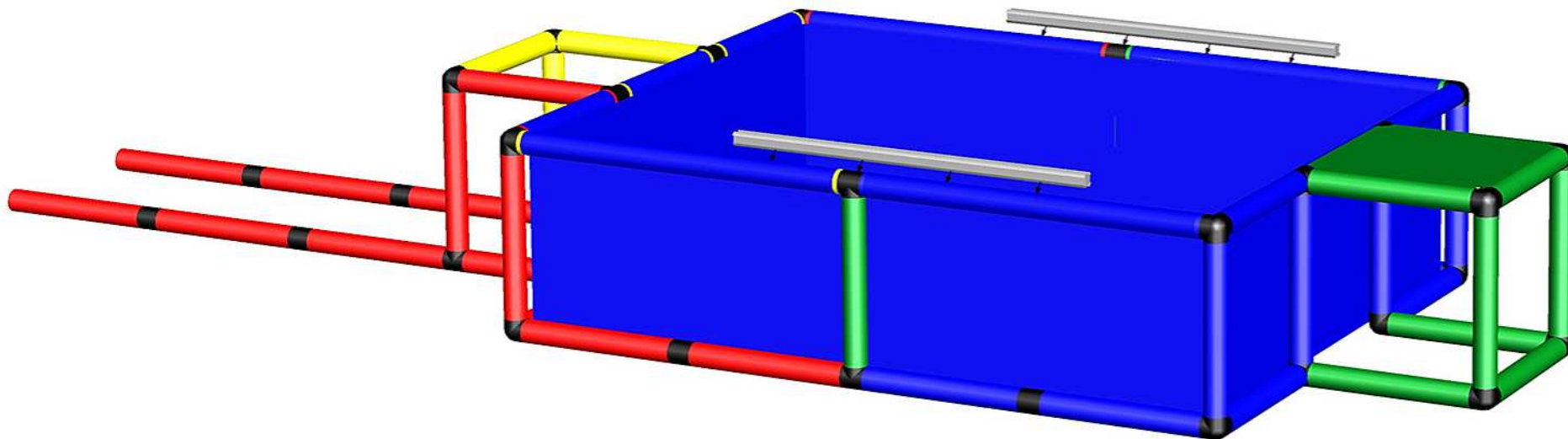

Please read the **Safety Manual** carefully before you start with assembling!

C0156 *Ultra Extreme Climbing Pyramid with Bridge, Modular Slide and Pool L*
To build this model you need: 6x 31002 + 11010 + 10010 + 11670 + 90913

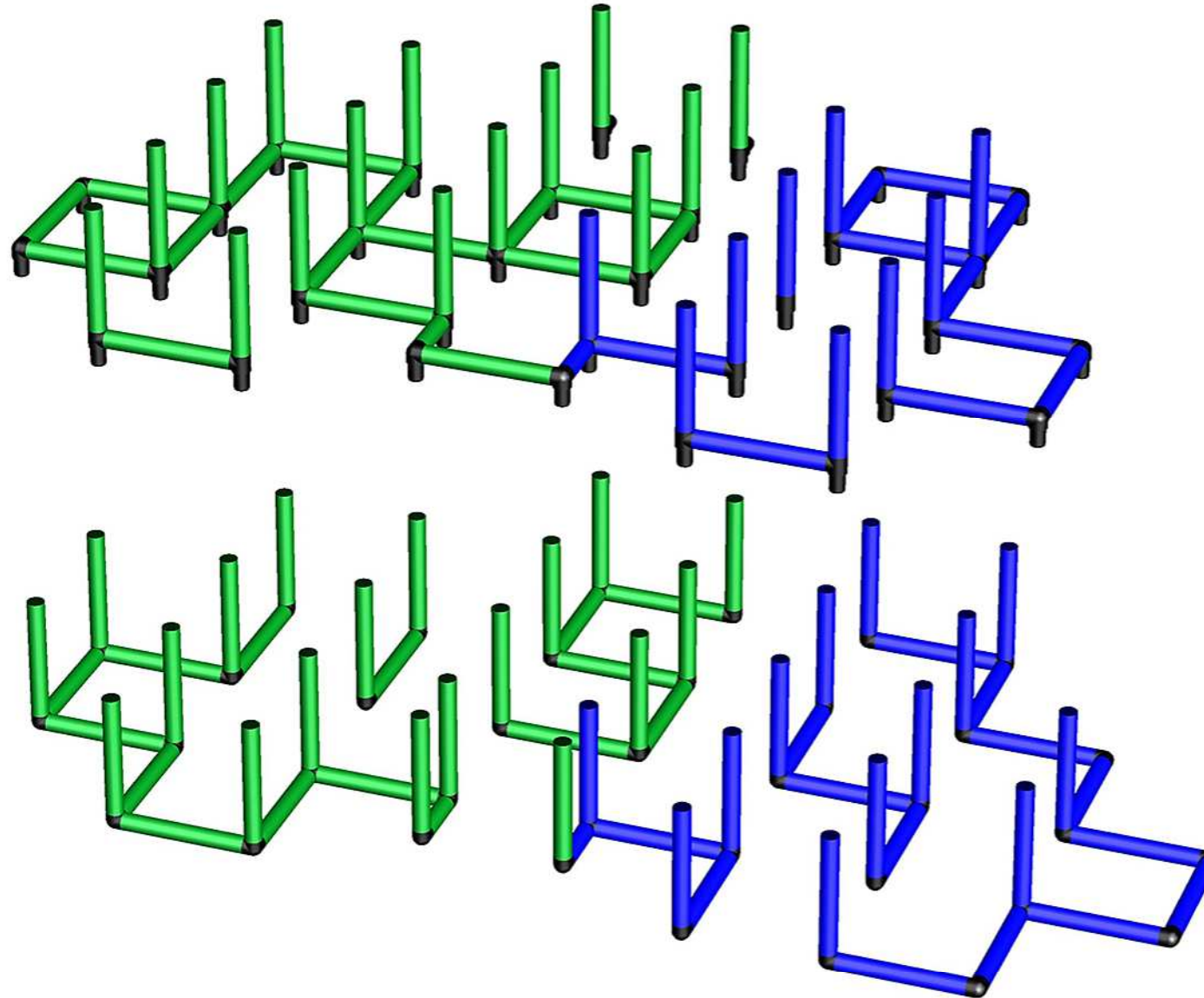

Caution Please read the **Safety Manual** carefully before you start with assembling!

C0156 *Ultra Extreme Climbing Pyramid with Bridge, Modular Slide and Pool L*
To build this model you need: 6x 31002 + 11010 + 10010 + 11670 + 90913

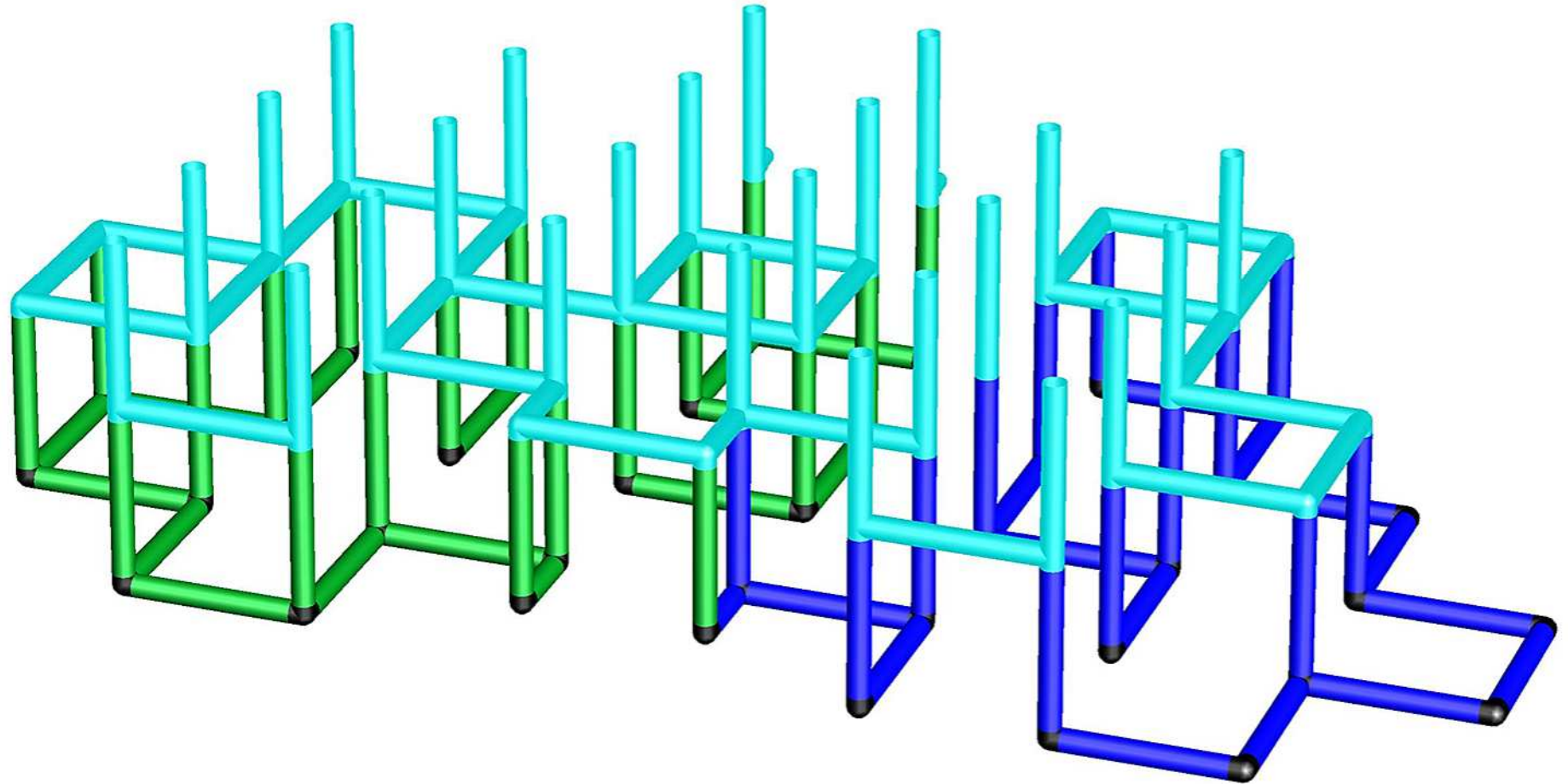

Please read the **Safety Manual** carefully before you start with assembling!

C0156 *Ultra Extreme Climbing Pyramid with Bridge, Modular Slide and Pool L*
To build this model you need: 6x 31002 + 11010 + 10010 + 11670 + 90913

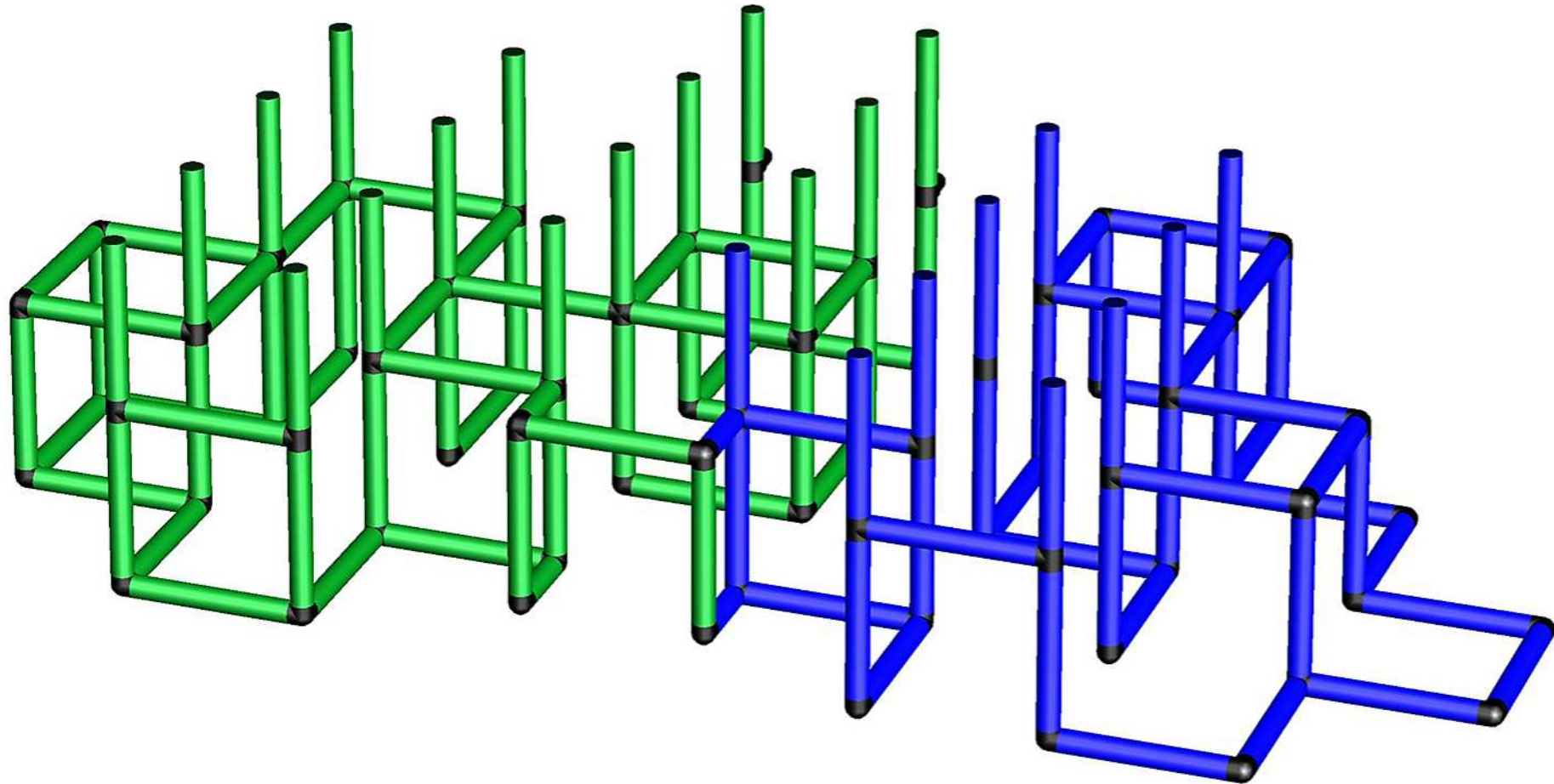

Please read the **Safety Manual** carefully before you start with assembling!

C0156 *Ultra Extreme Climbing Pyramid with Bridge, Modular Slide and Pool L*
To build this model you need: 6x 31002 + 11010 + 10010 + 11670 + 90913

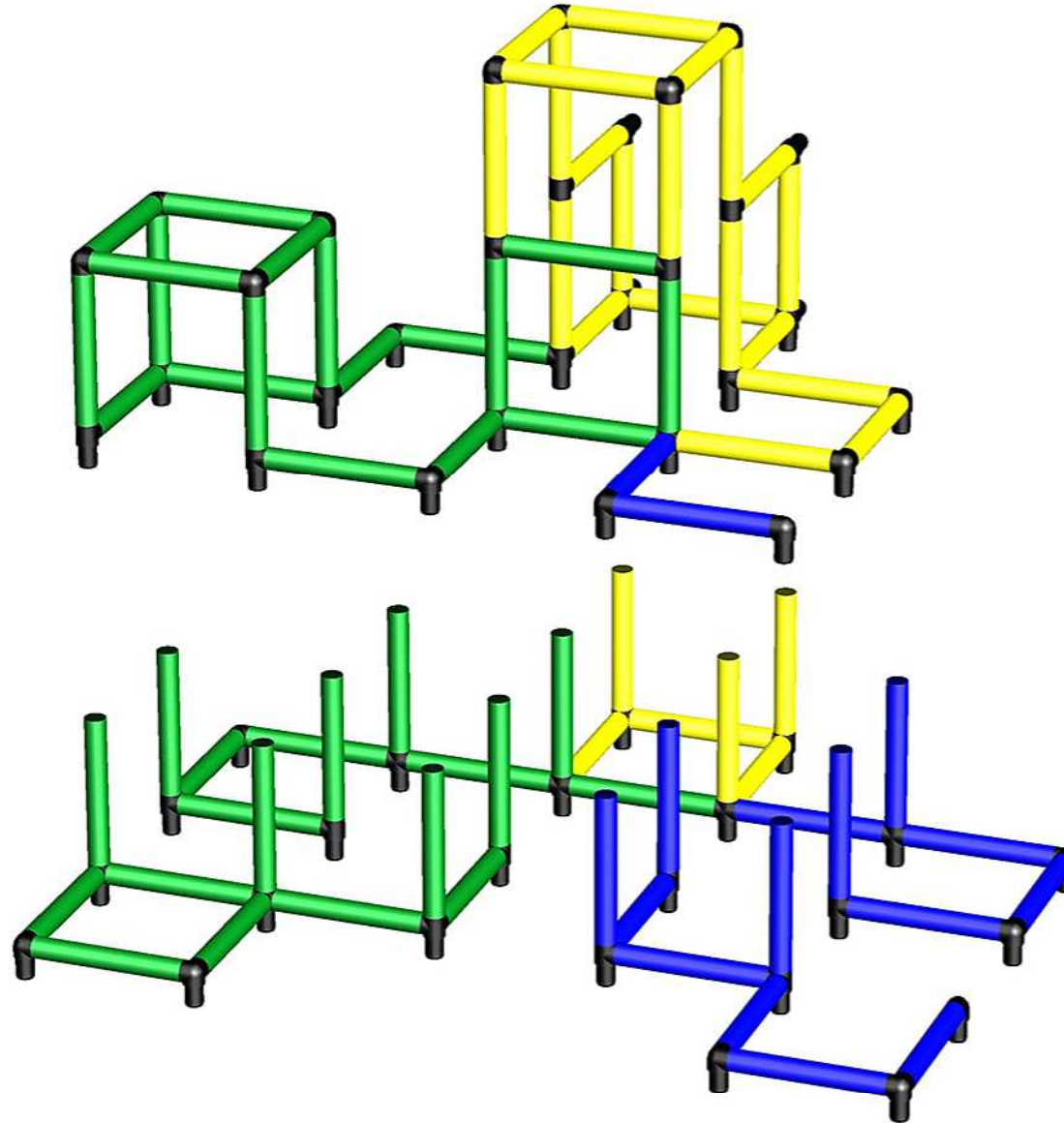

Please read the **Safety Manual** carefully before you start with
assembling!

C0156 *Ultra Extreme Climbing Pyramid with Bridge, Modular Slide and Pool L*
To build this model you need: 6x 31002 + 11010 + 10010 + 11670 + 90913

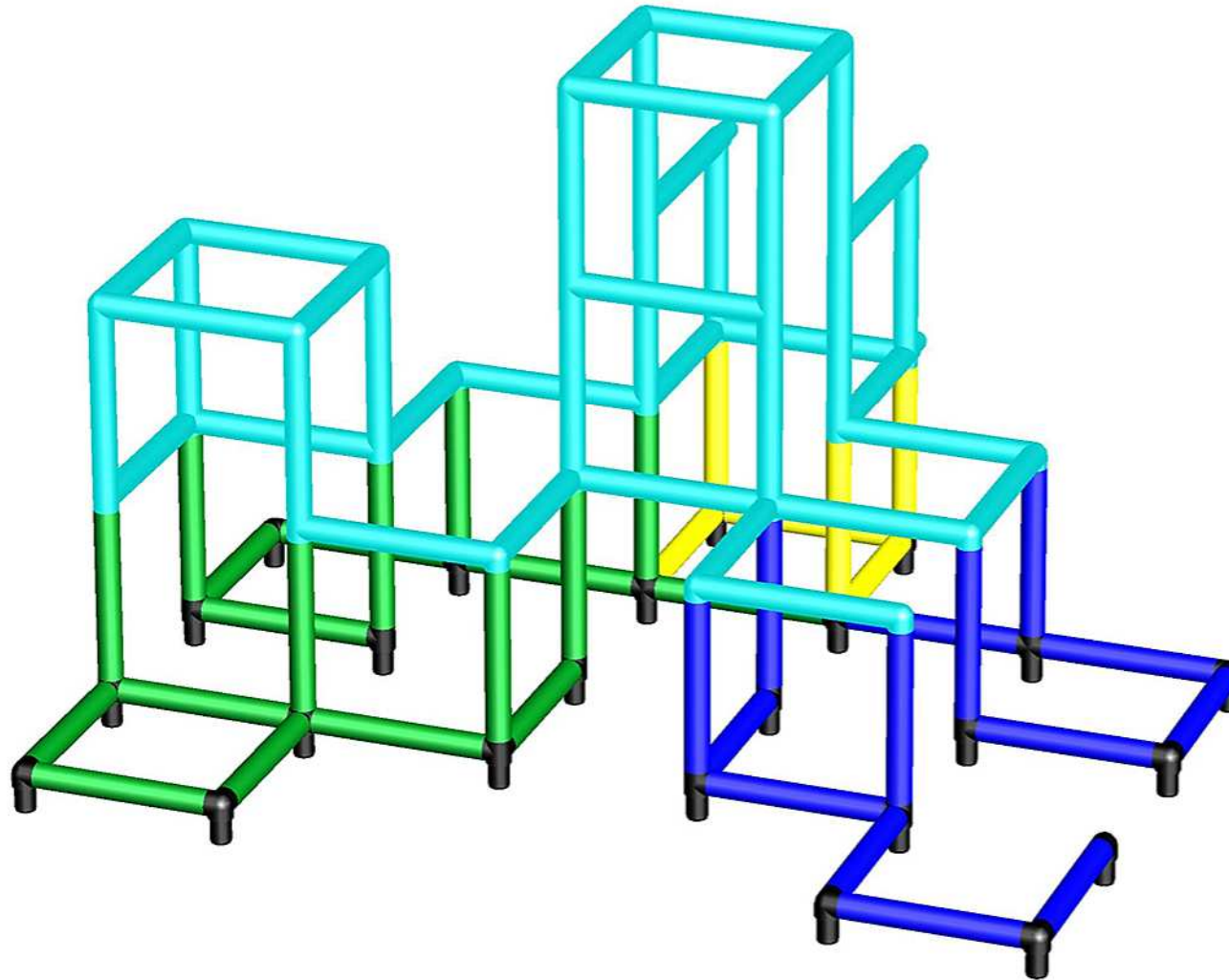

Please read the **Safety Manual** carefully before you start with assembling!

C0156 *Ultra Extreme Climbing Pyramid with Bridge, Modular Slide and Pool L*
To build this model you need: 6x 31002 + 11010 + 10010 + 11670 + 90913

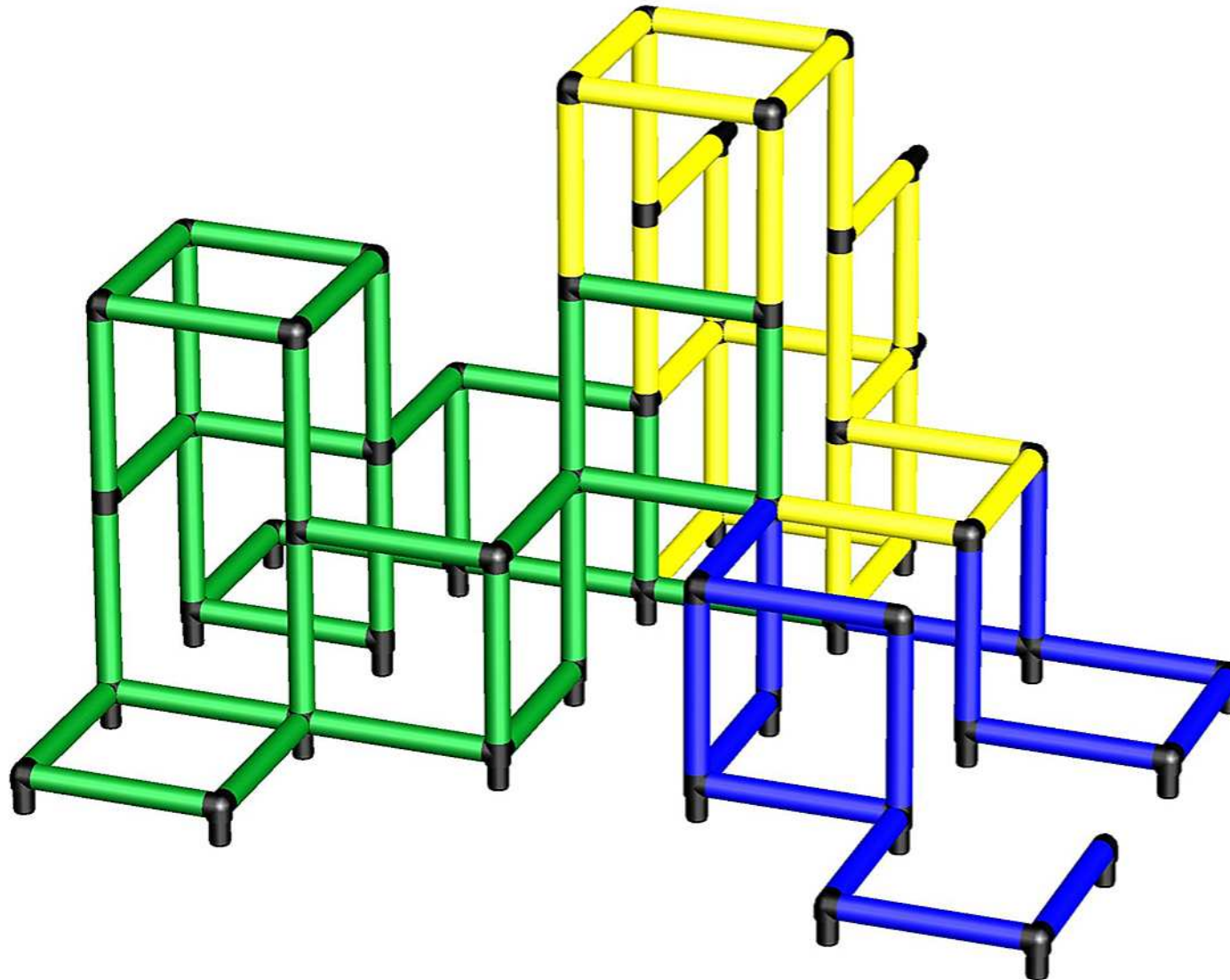

Please read the **Safety Manual** carefully before you start with assembling!

C0156 *Ultra Extreme Climbing Pyramid with Bridge, Modular Slide and Pool L*
To build this model you need: 6x 31002 + 11010 + 10010 + 11670 + 90913

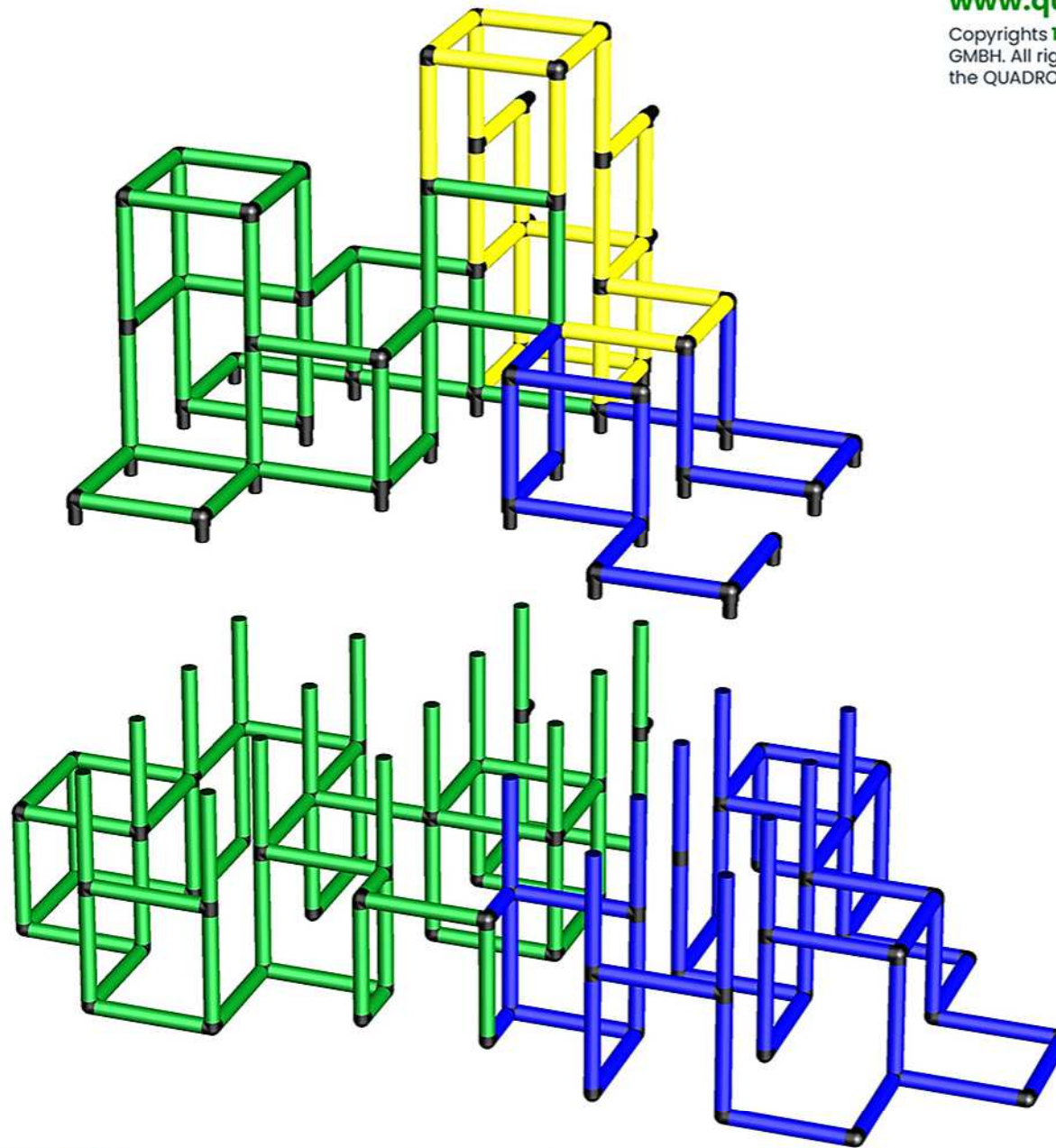

Caution Please read the **Safety Manual** carefully before you start with assembling!

C0156 *Ultra Extreme Climbing Pyramid with Bridge, Modular Slide and Pool L*
To build this model you need: 6x 31002 + 11010 + 10010 + 11670 + 90913

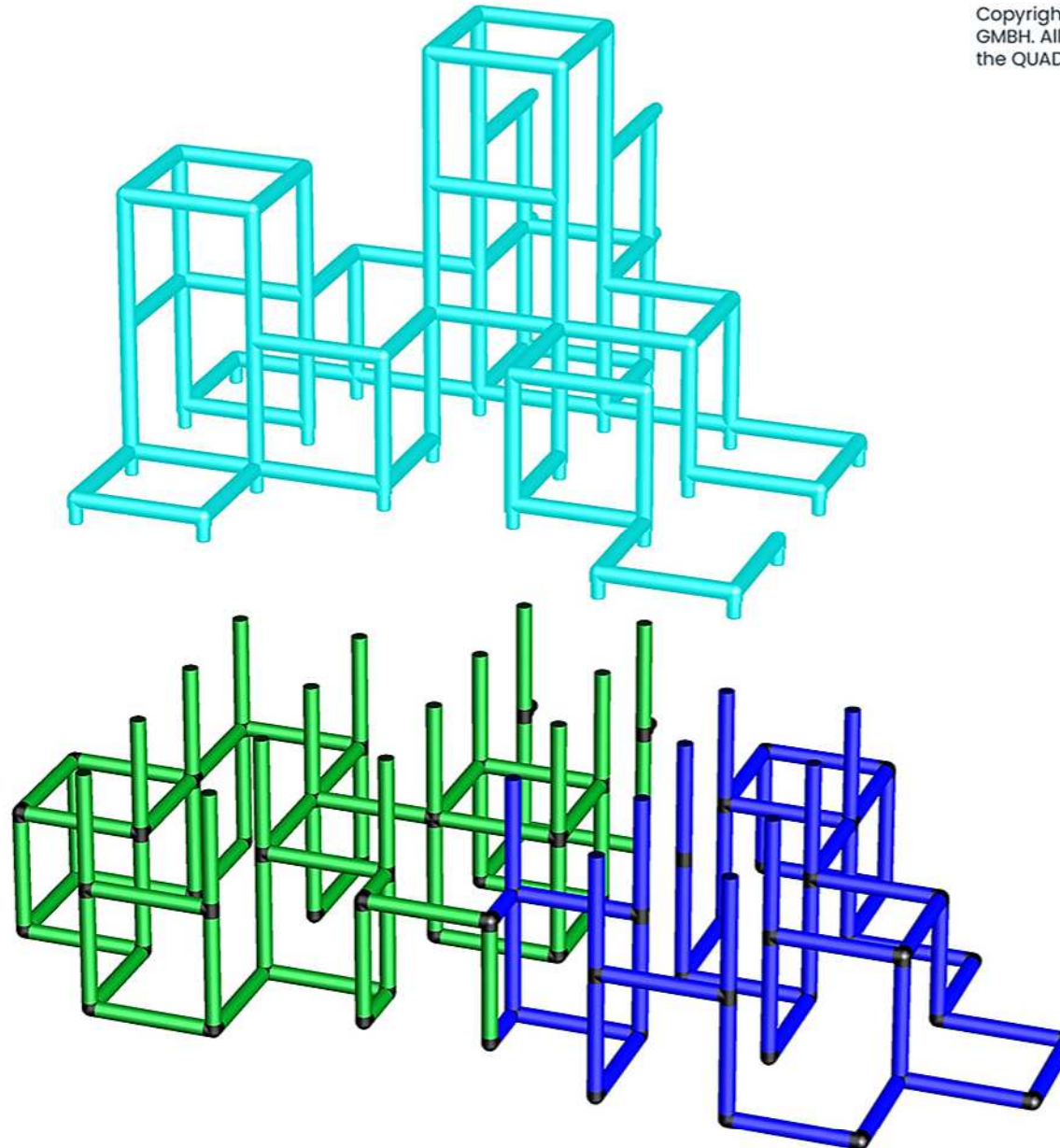

Please read the **Safety Manual** carefully before you start with assembling!

C0156 *Ultra Extreme Climbing Pyramid with Bridge, Modular Slide and Pool L*
To build this model you need: 6x 31002 + 11010 + 10010 + 11670 + 90913

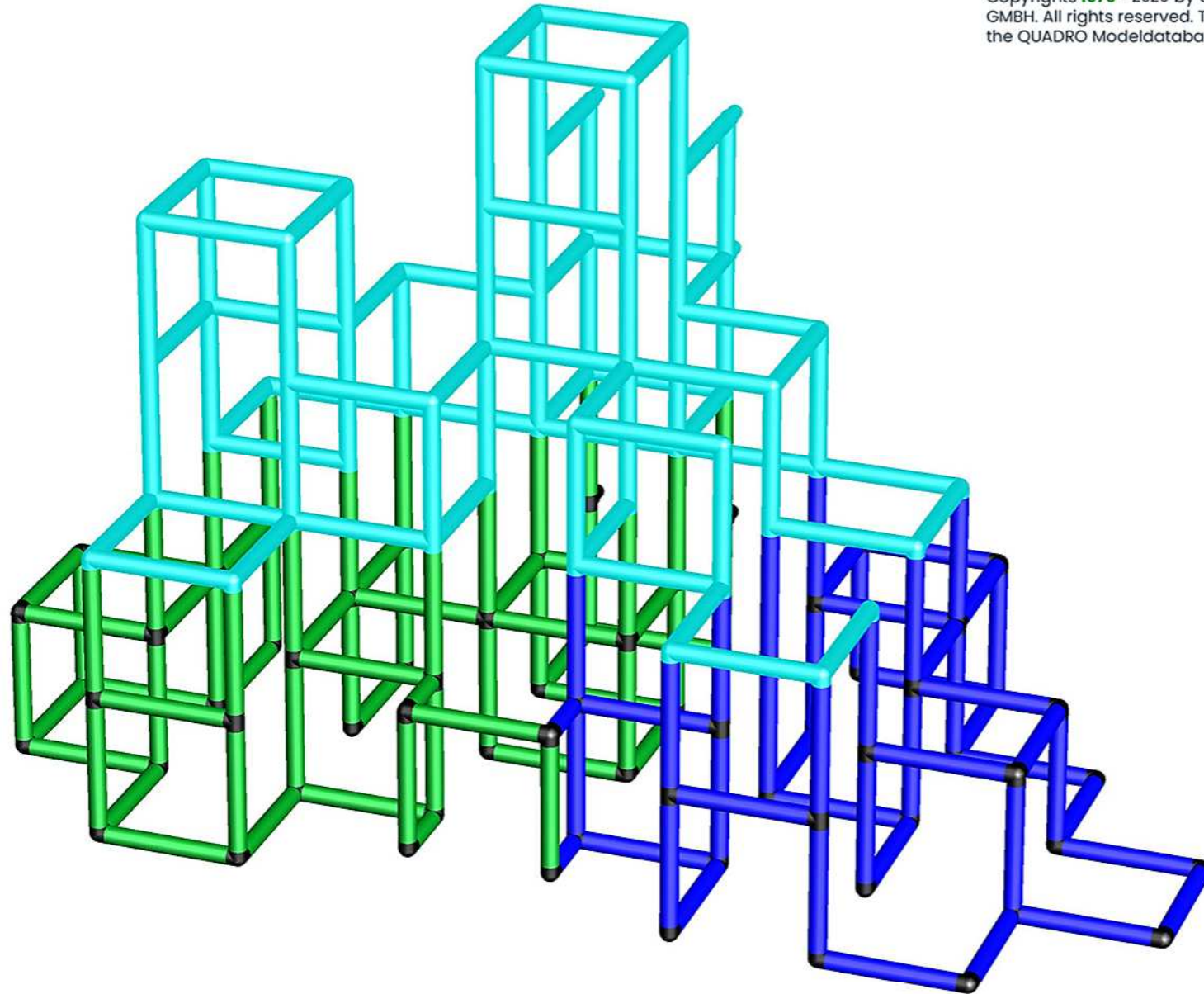

Please read the **Safety Manual** carefully before you start with
assembling!

C0156 *Ultra Extreme Climbing Pyramid with Bridge, Modular Slide and Pool L*
To build this model you need: 6x 31002 + 11010 + 10010 + 11670 + 90913

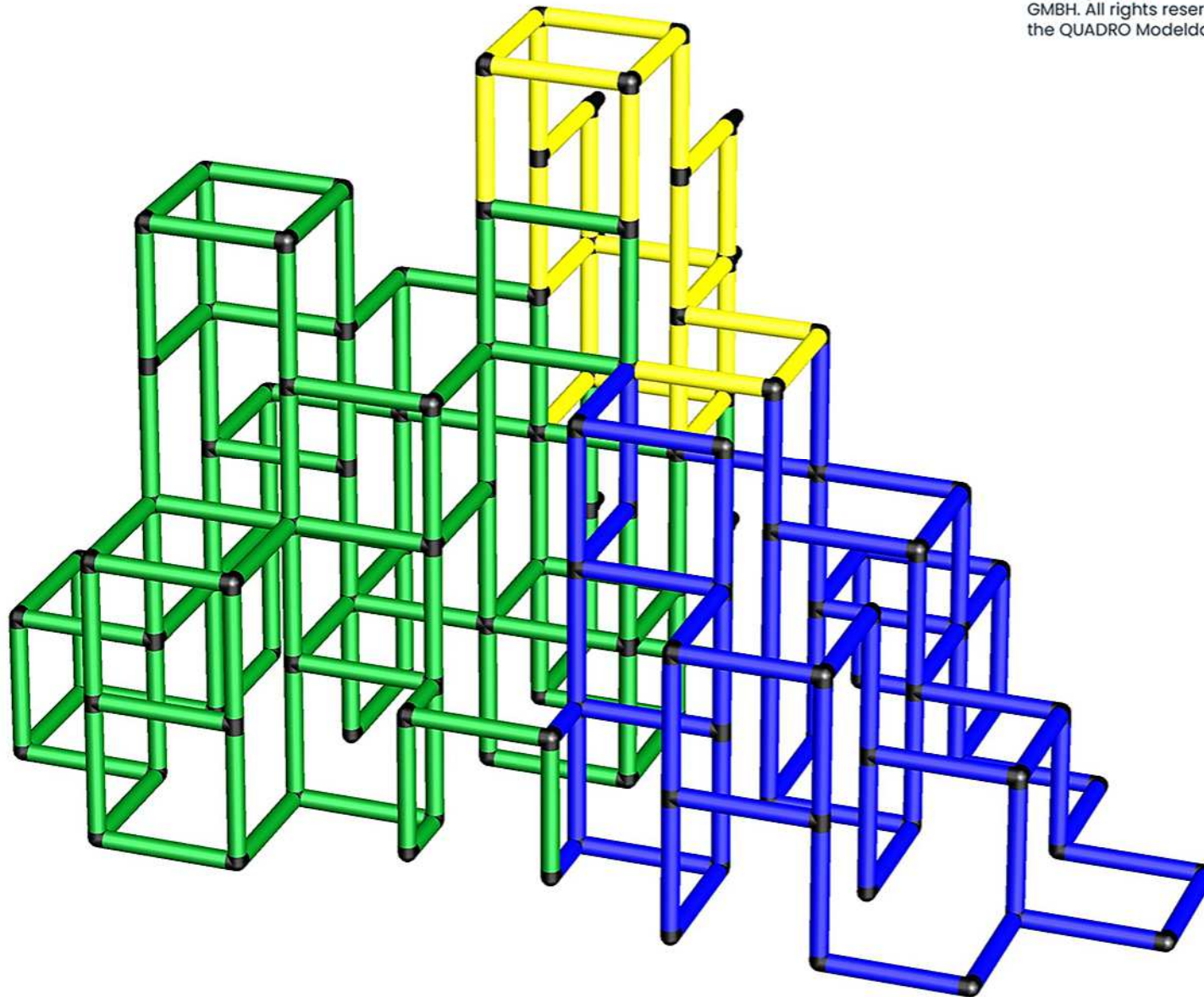

Caution Please read the **Safety Manual** carefully before you start with assembling!

C0156 *Ultra Extreme Climbing Pyramid with Bridge, Modular Slide and Pool L*
To build this model you need: 6x 31002 + 11010 + 10010 + 11670 + 90913

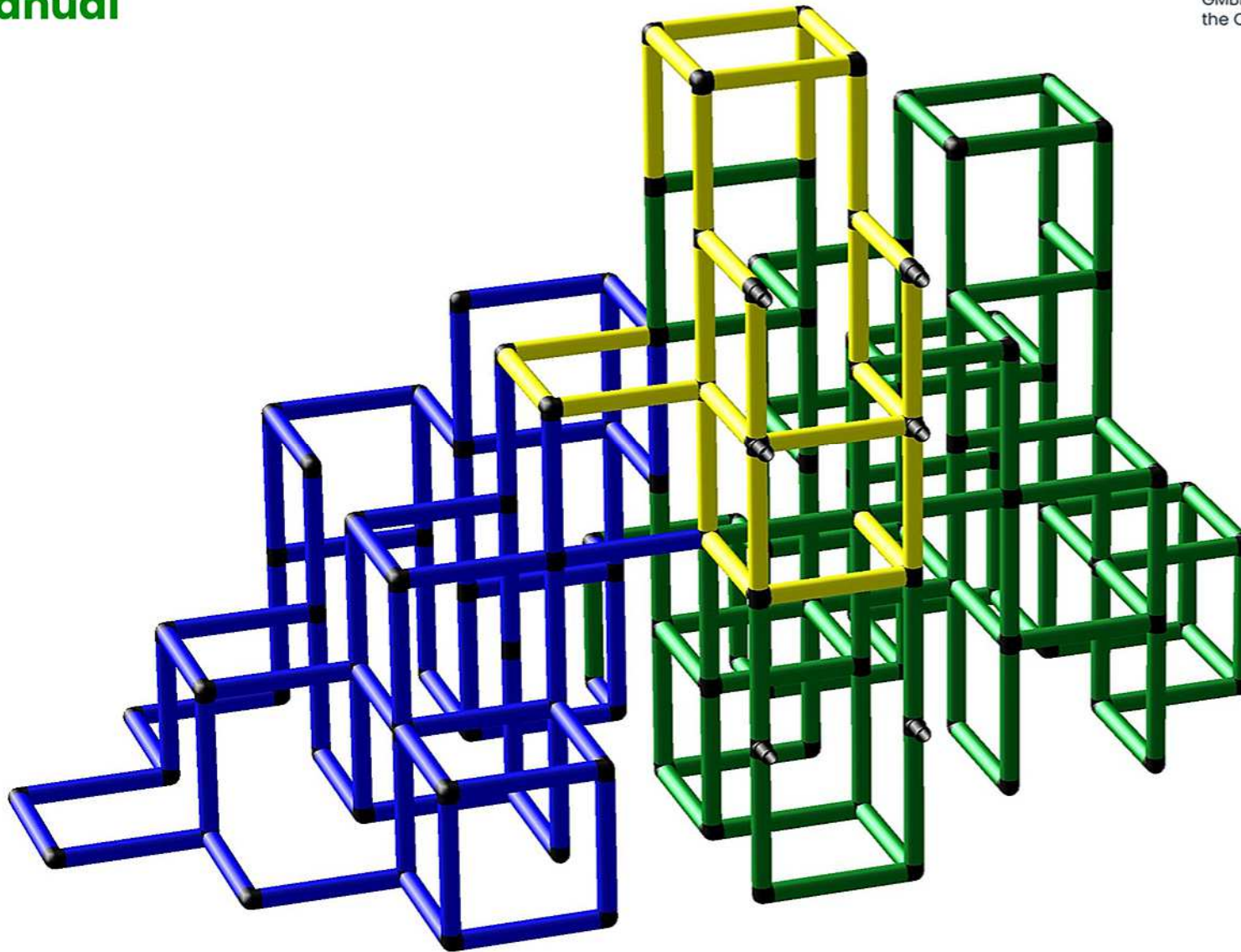

Please read the **Safety Manual** carefully before you start with assembling!

C0156 *Ultra Extreme Climbing Pyramid with Bridge, Modular Slide and Pool L*
To build this model you need: 6x 31002 + 11010 + 10010 + 11670 + 90913

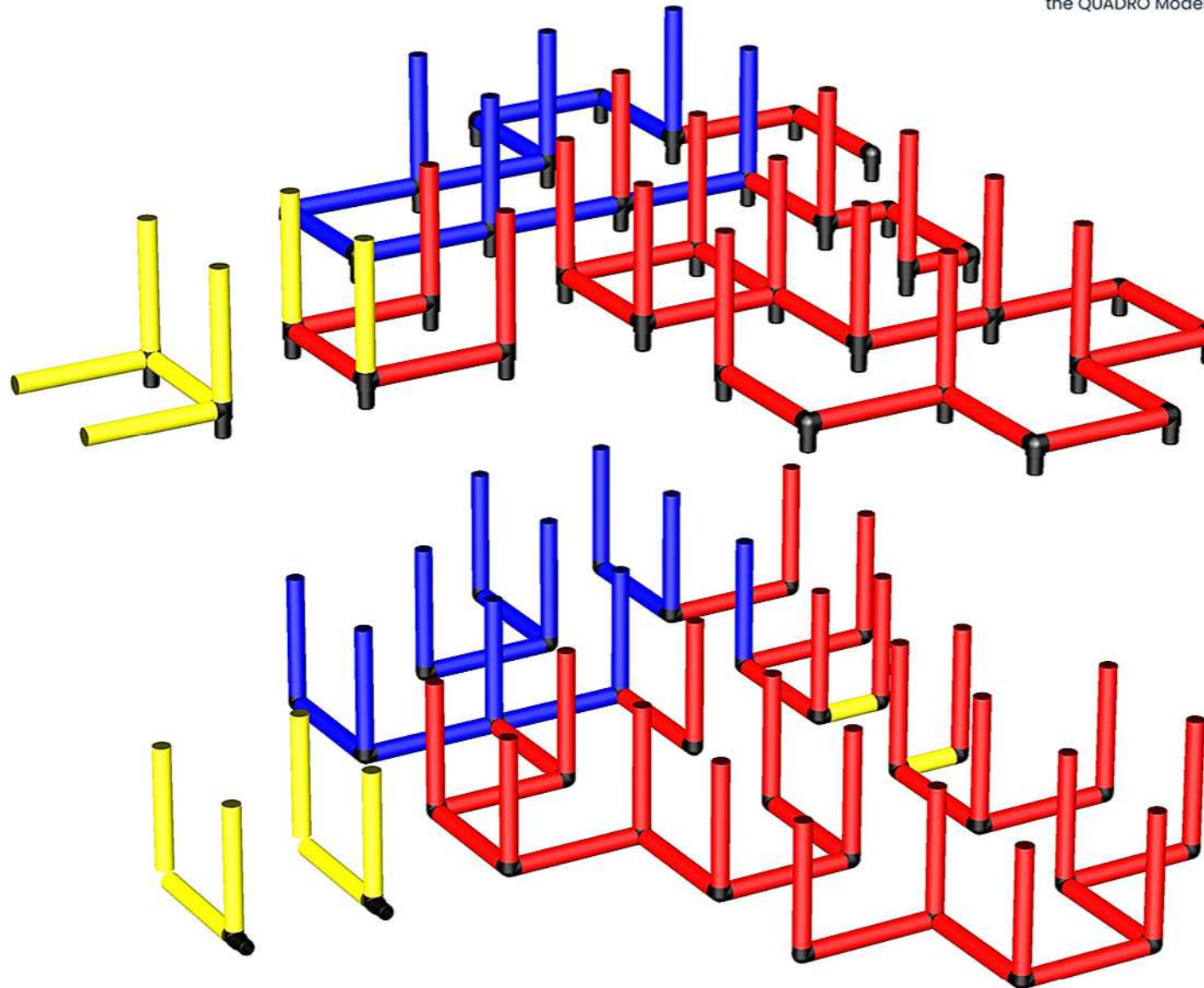

Please read the **Safety Manual** carefully before you start with assembling!

C0156 *Ultra Extreme Climbing Pyramid with Bridge, Modular Slide and Pool L*
To build this model you need: 6x 31002 + 11010 + 10010 + 11670 + 90913

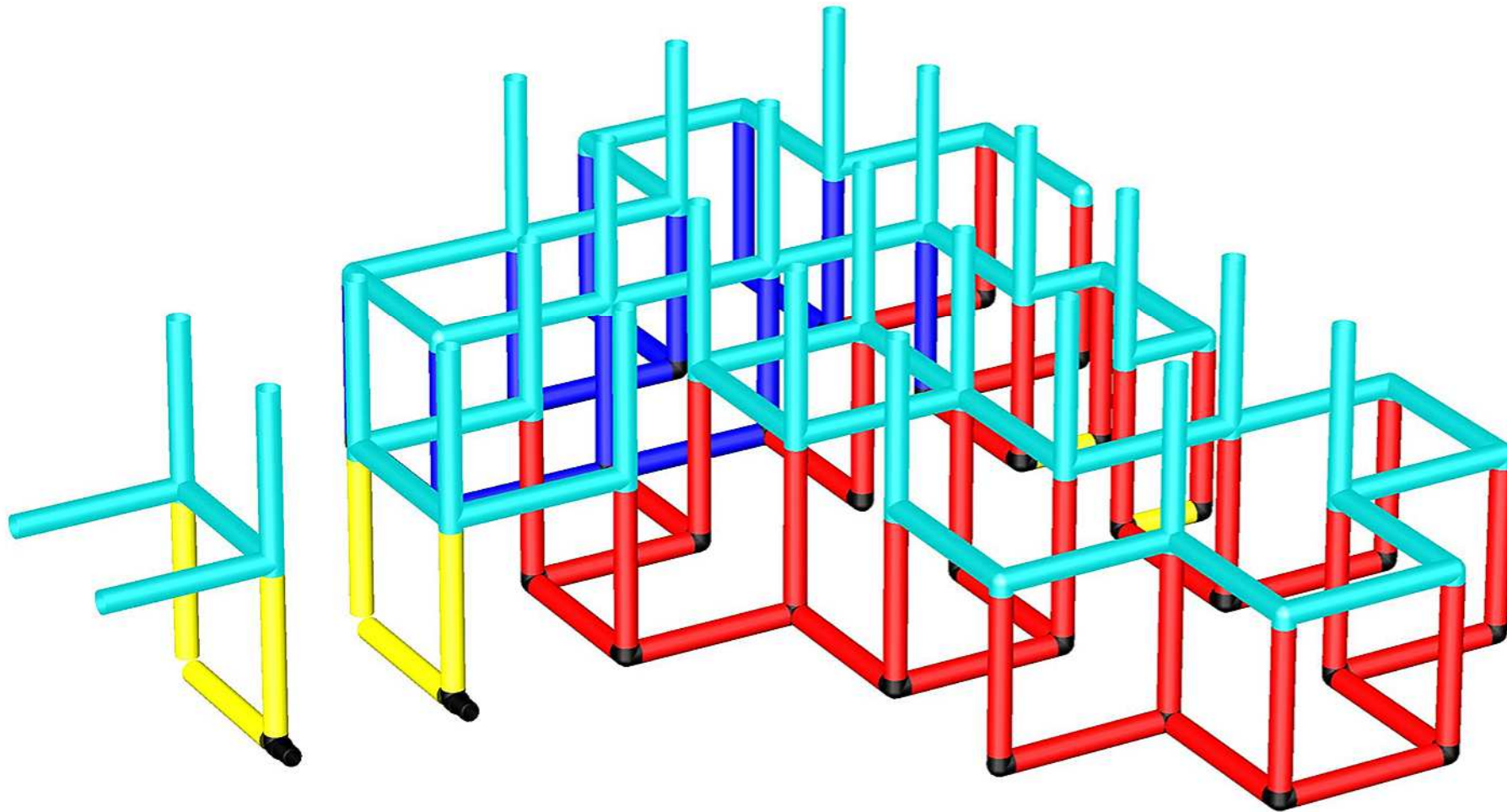

Caution Please read the **Safety Manual** carefully before you start with assembling!

C0156 *Ultra Extreme Climbing Pyramid with Bridge, Modular Slide and Pool L*
To build this model you need: 6x 31002 + 11010 + 10010 + 11670 + 90913

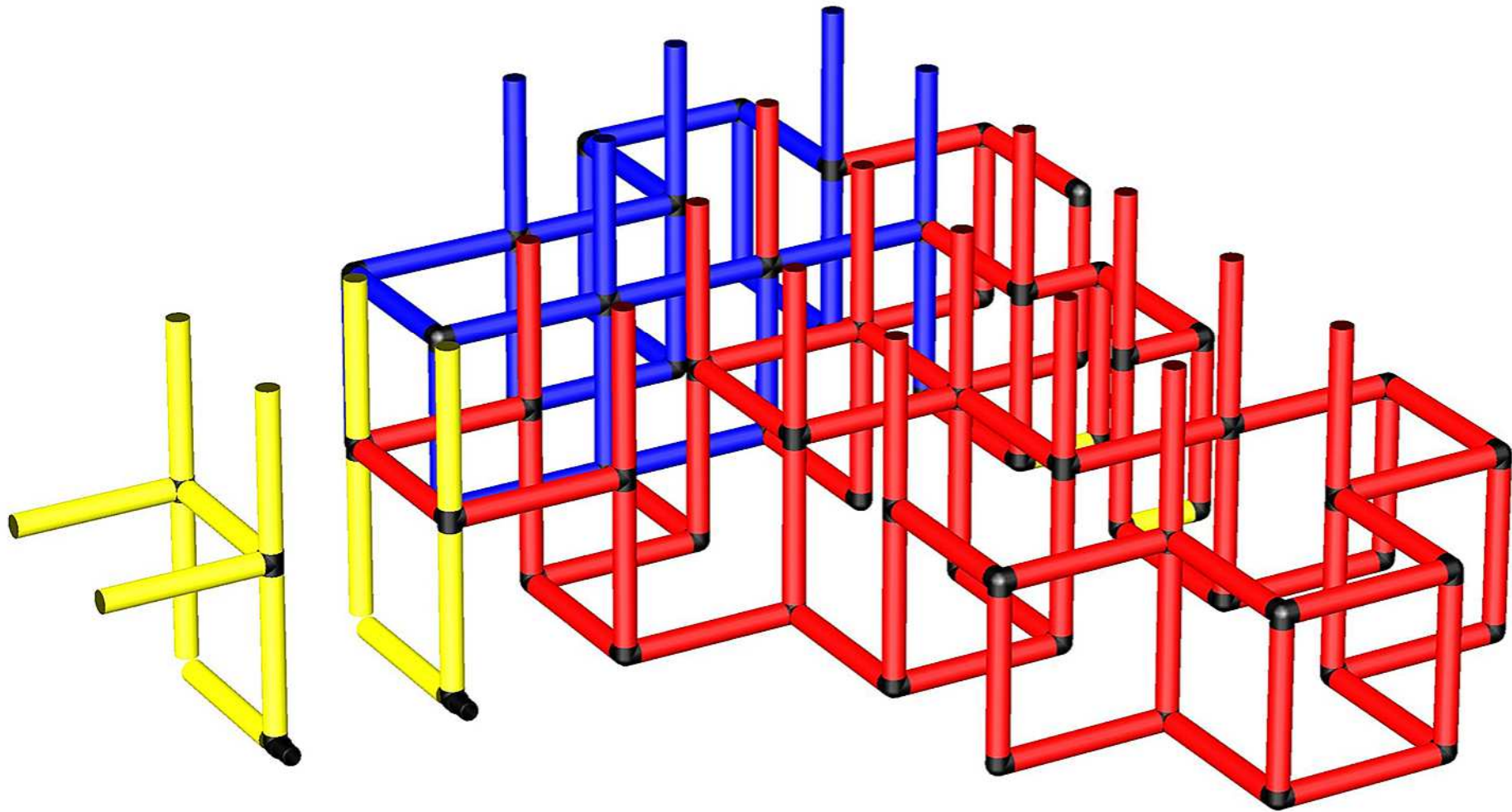

Caution Please read the **Safety Manual** carefully before you start with assembling!

C0156 *Ultra Extreme Climbing Pyramid with Bridge, Modular Slide and Pool L*
To build this model you need: 6x 31002 + 11010 + 10010 + 11670 + 90913

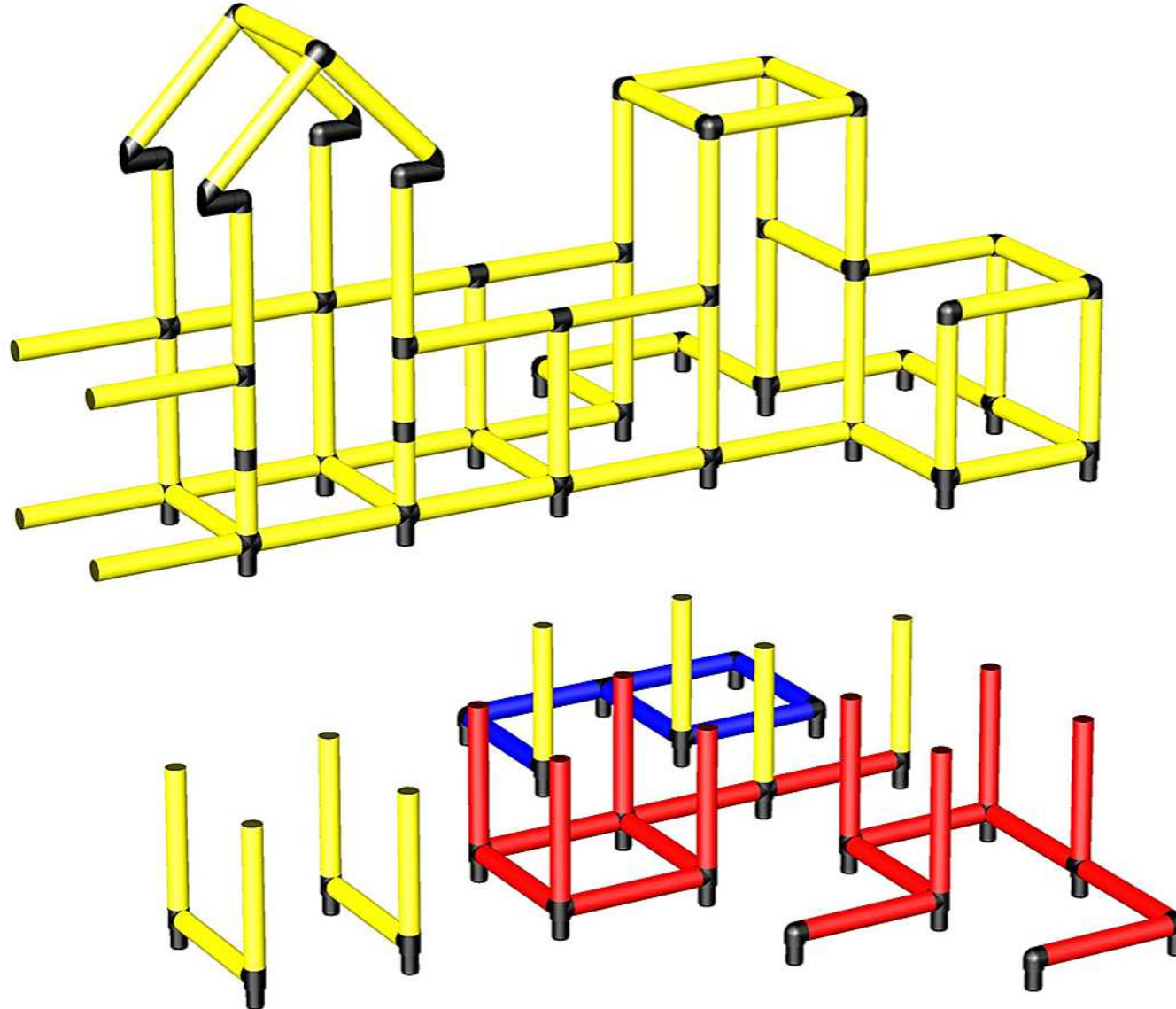

Caution Please read the **Safety Manual** carefully before you start with assembling!

C0156 *Ultra Extreme Climbing Pyramid with Bridge, Modular Slide and Pool L*
To build this model you need: 6x 31002 + 11010 + 10010 + 11670 + 90913

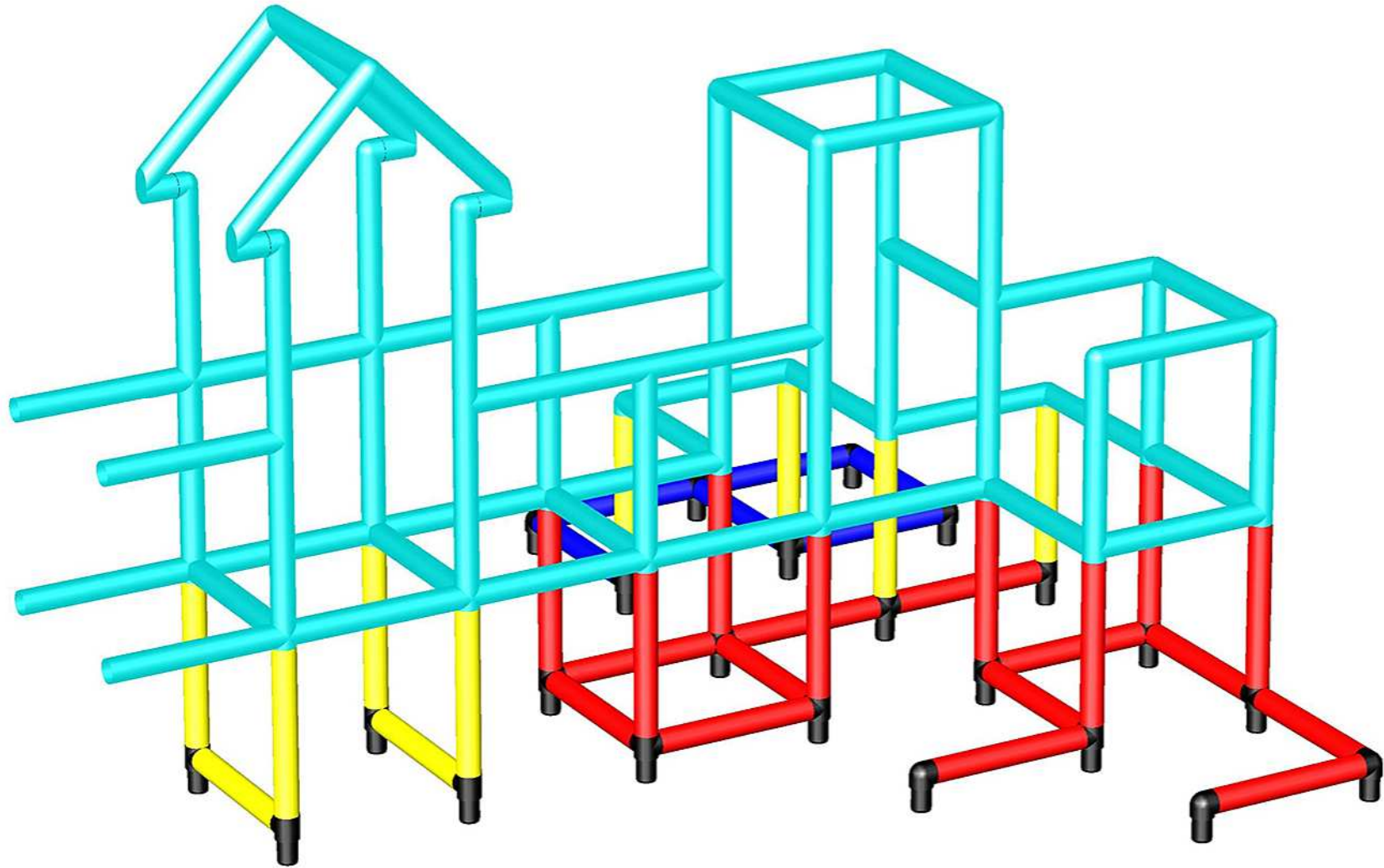

Caution Please read the **Safety Manual** carefully before you start with assembling!

C0156 *Ultra Extreme Climbing Pyramid with Bridge, Modular Slide and Pool L*
To build this model you need: 6x 31002 + 11010 + 10010 + 11670 + 90913

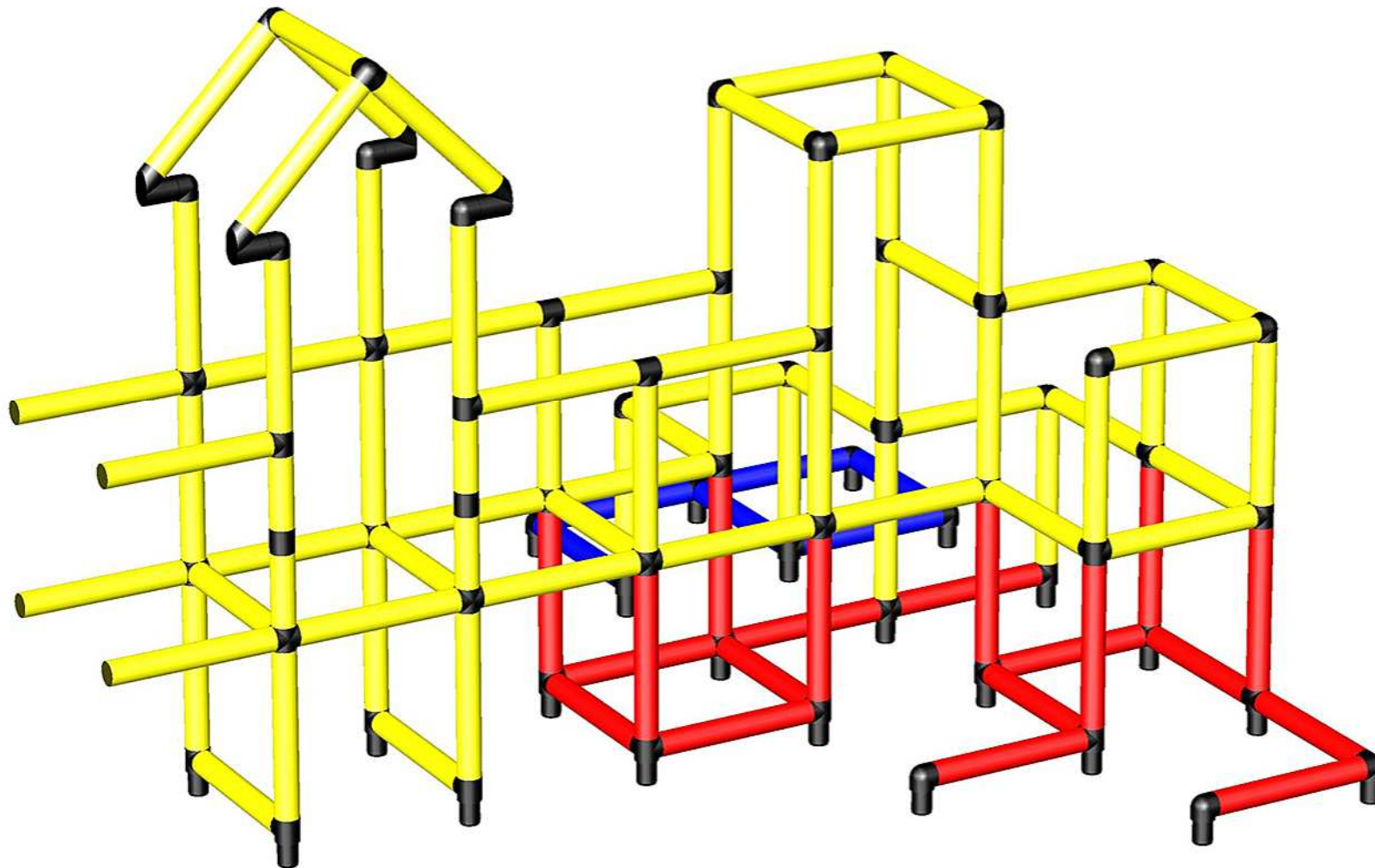

Please read the **Safety Manual** carefully before you start with assembling!

C0156 *Ultra Extreme Climbing Pyramid with Bridge, Modular Slide and Pool L*
To build this model you need: 6x 31002 + 11010 + 10010 + 11670 + 90913

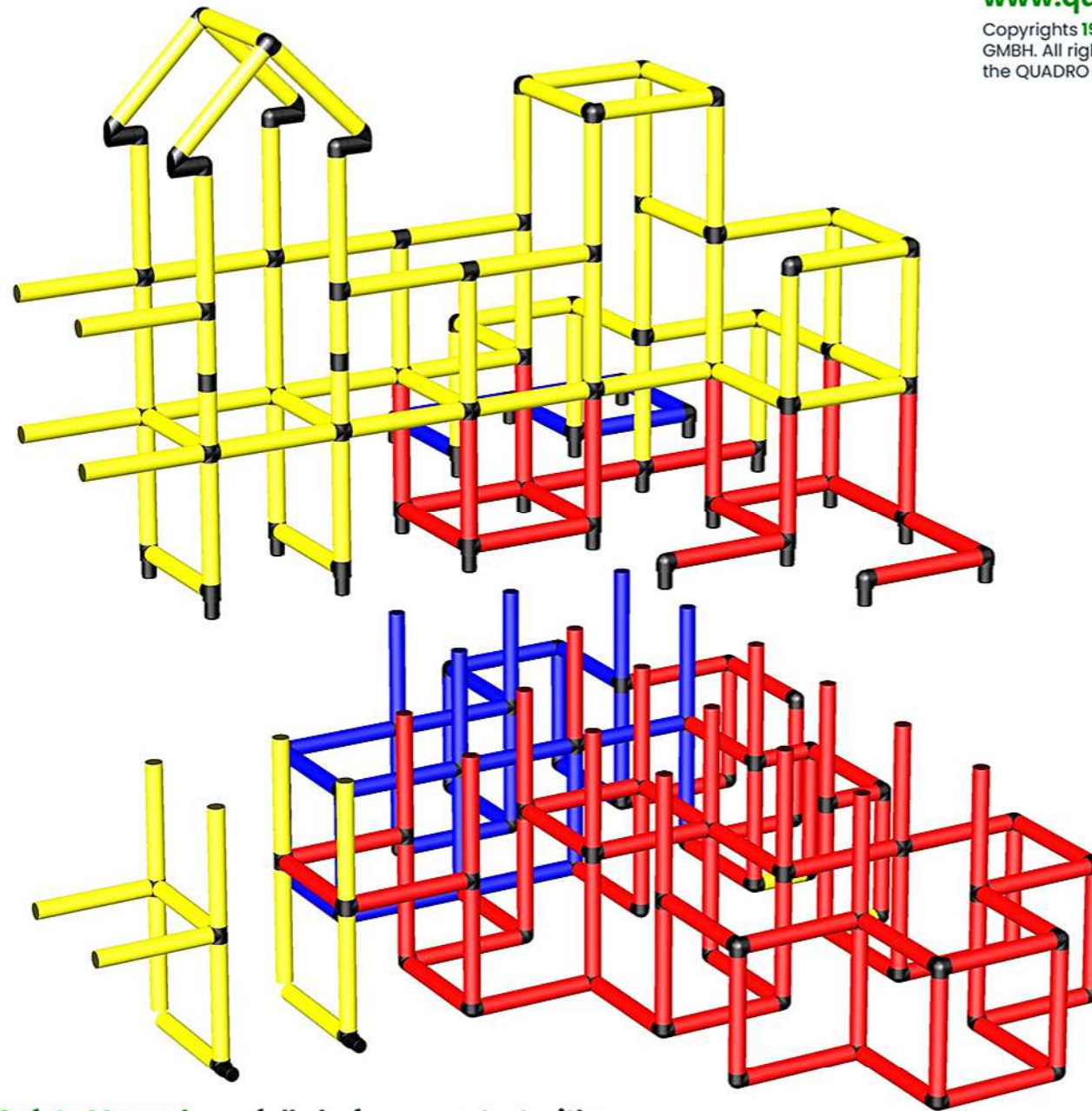

Caution Please read the **Safety Manual** carefully before you start with assembling!

C0156 *Ultra Extreme Climbing Pyramid with Bridge, Modular Slide and Pool L*
To build this model you need: 6x 31002 + 11010 + 10010 + 11670 + 90913

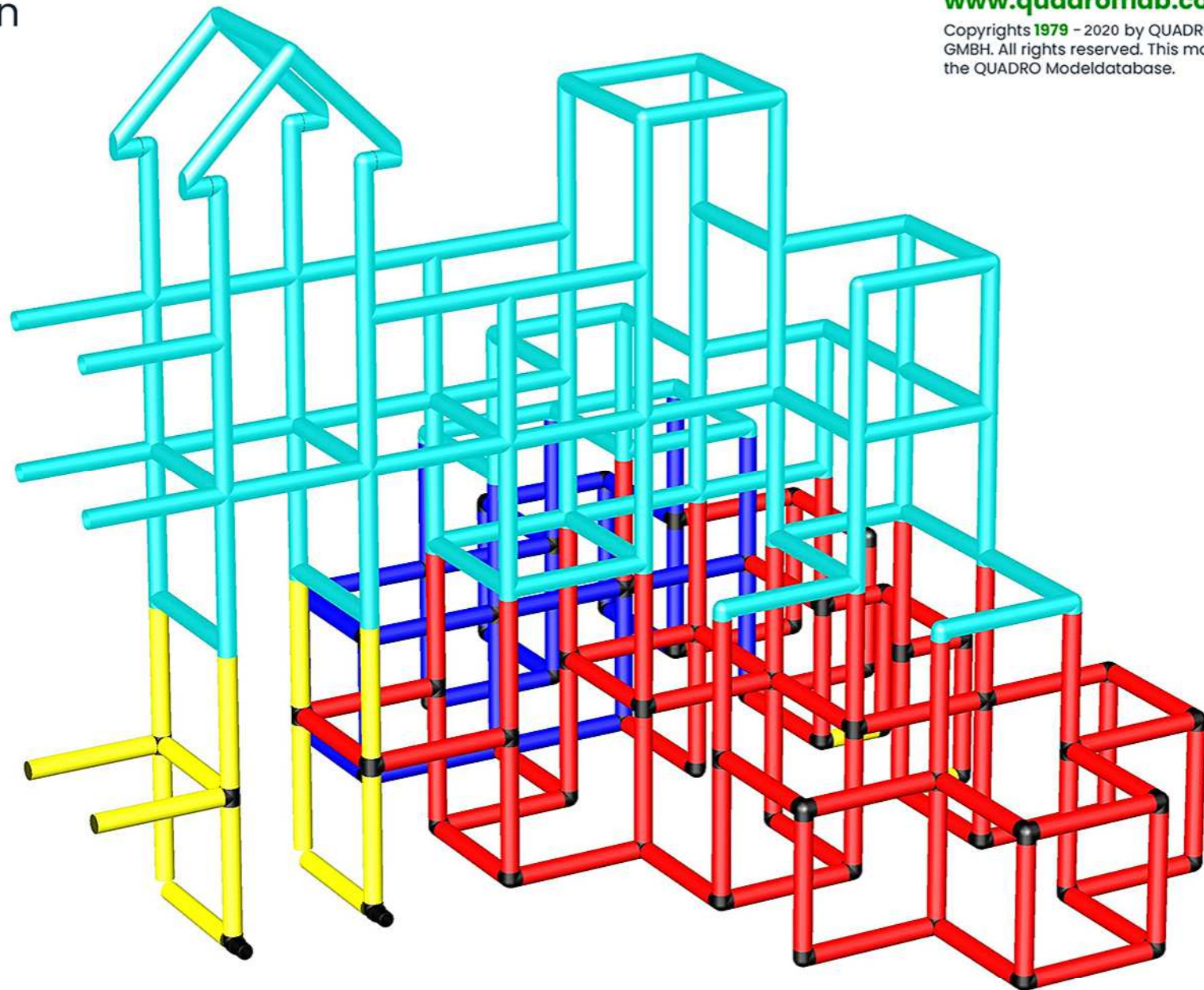

Please read the **Safety Manual** carefully before you start with
assembling!

C0156 *Ultra Extreme Climbing Pyramid with Bridge, Modular Slide and Pool L*
To build this model you need: 6x 31002 + 11010 + 10010 + 11670 + 90913

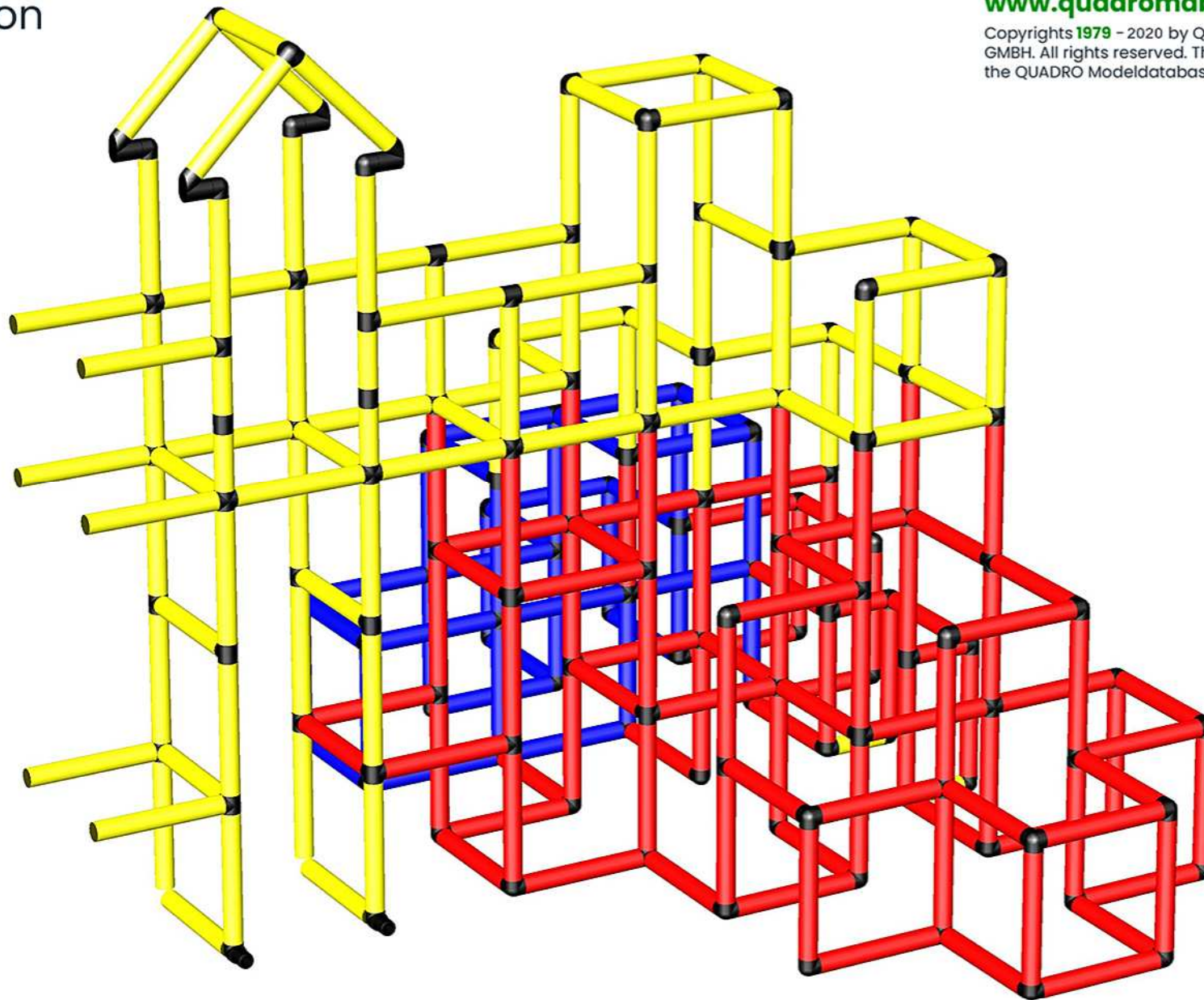

Please read the **Safety Manual** carefully before you start with assembling!

C0156 *Ultra Extreme Climbing Pyramid with Bridge, Modular Slide and Pool L*
To build this model you need: 6x 31002 + 11010 + 10010 + 11670 + 90913

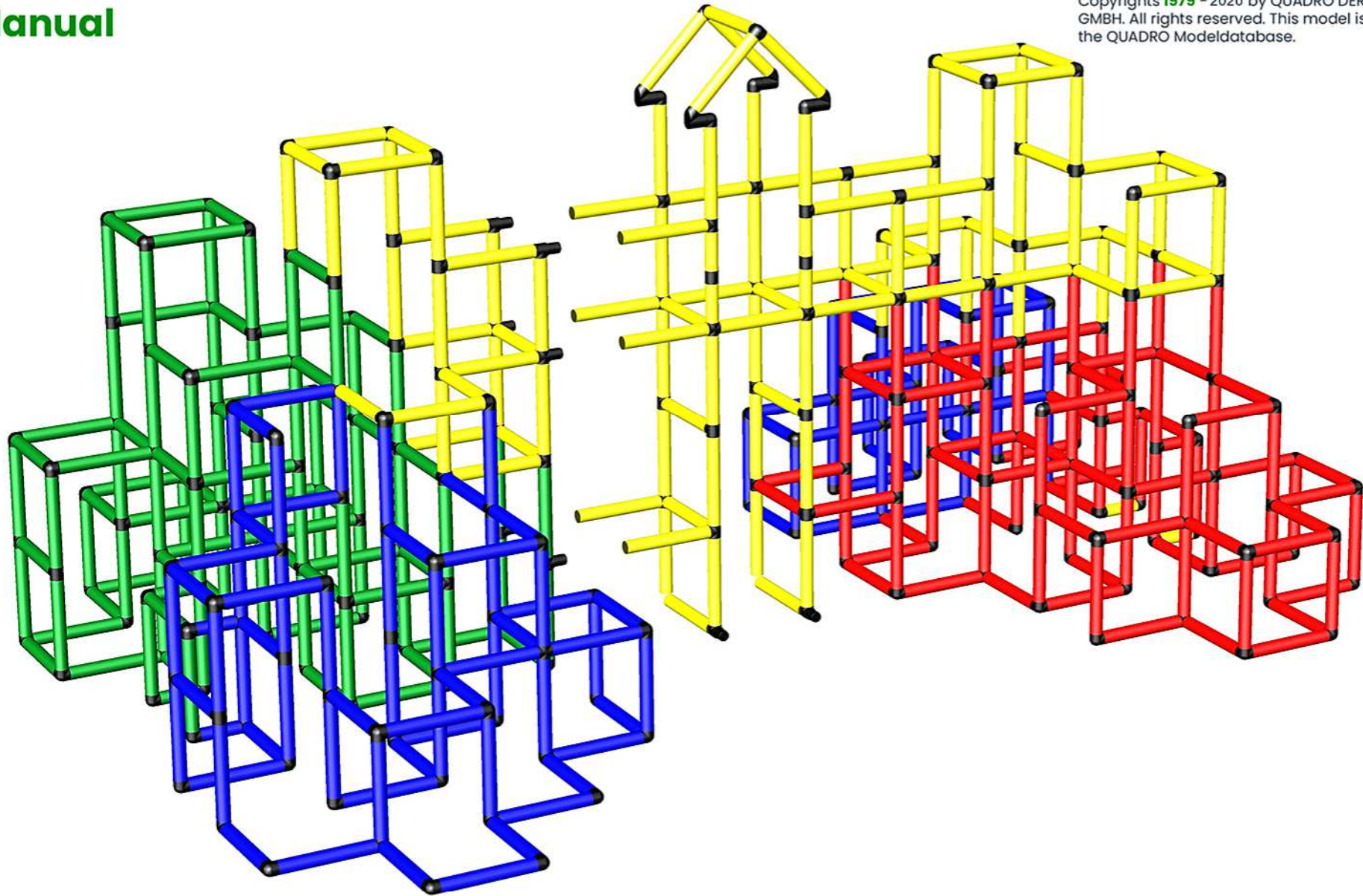

Please read the **Safety Manual** carefully before you start with assembling!

C0156 *Ultra Extreme Climbing Pyramid with Bridge, Modular Slide and Pool L*
To build this model you need: 6x 31002 + 11010 + 10010 + 11670 + 90913

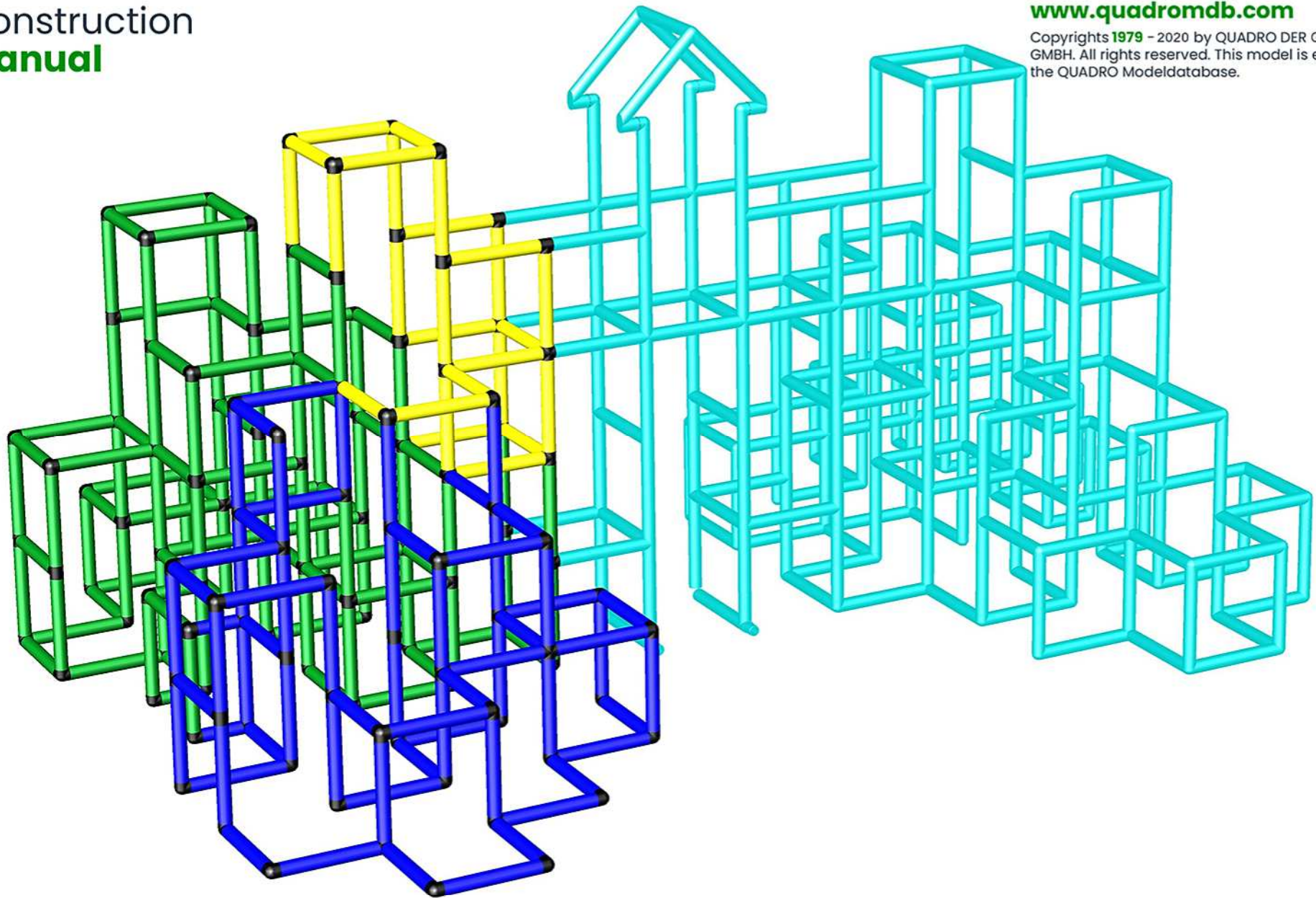

Caution Please read the **Safety Manual** carefully before you start with assembling!

C0156 *Ultra Extreme Climbing Pyramid with Bridge, Modular Slide and Pool L*
To build this model you need: 6x 31002 + 11010 + 10010 + 11670 + 90913

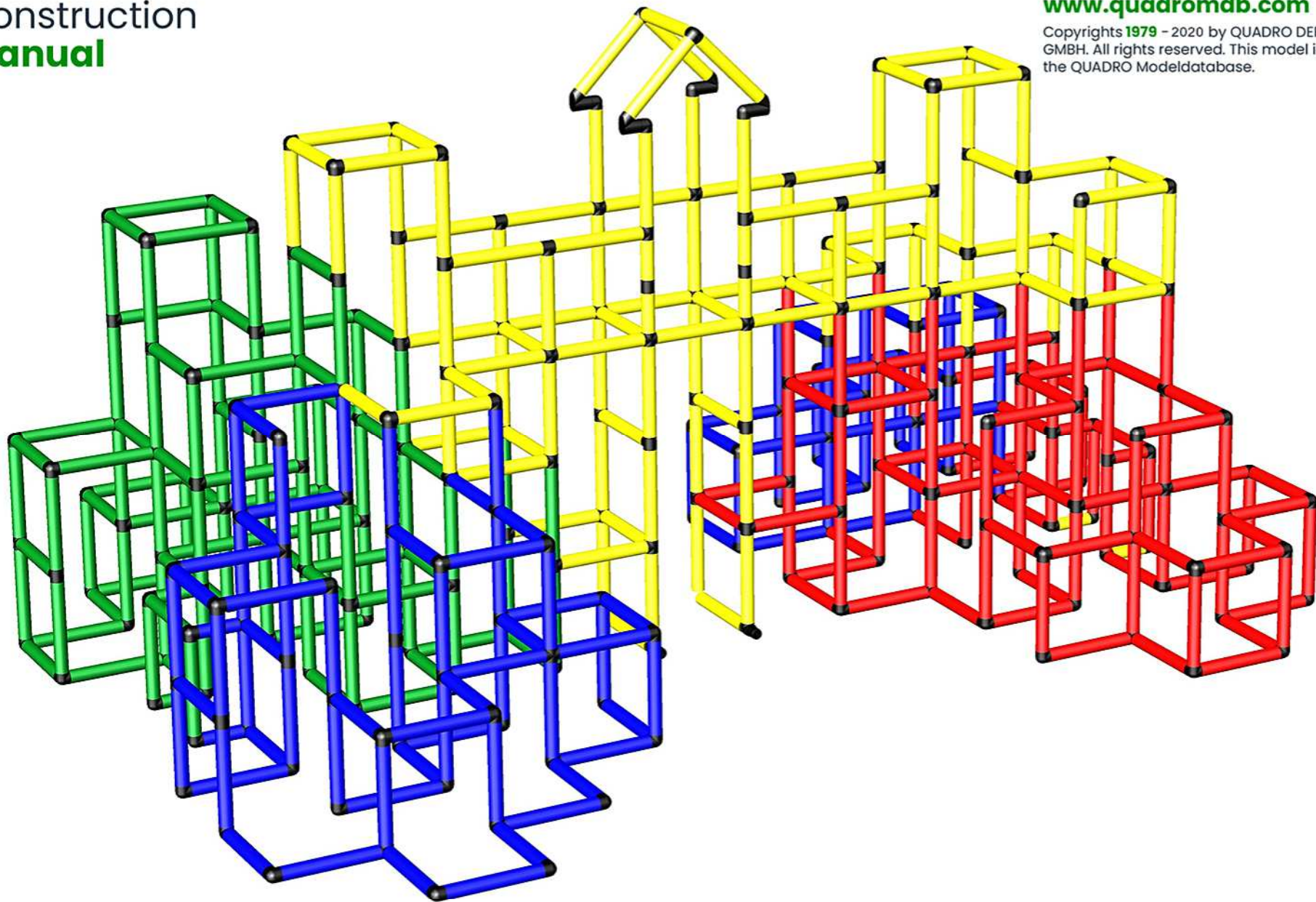

Please read the **Safety Manual** carefully before you start with assembling!

C0156 *Ultra Extreme Climbing Pyramid with Bridge, Modular Slide and Pool L*
To build this model you need: 6x 31002 + 11010 + 10010 + 11670 + 90913

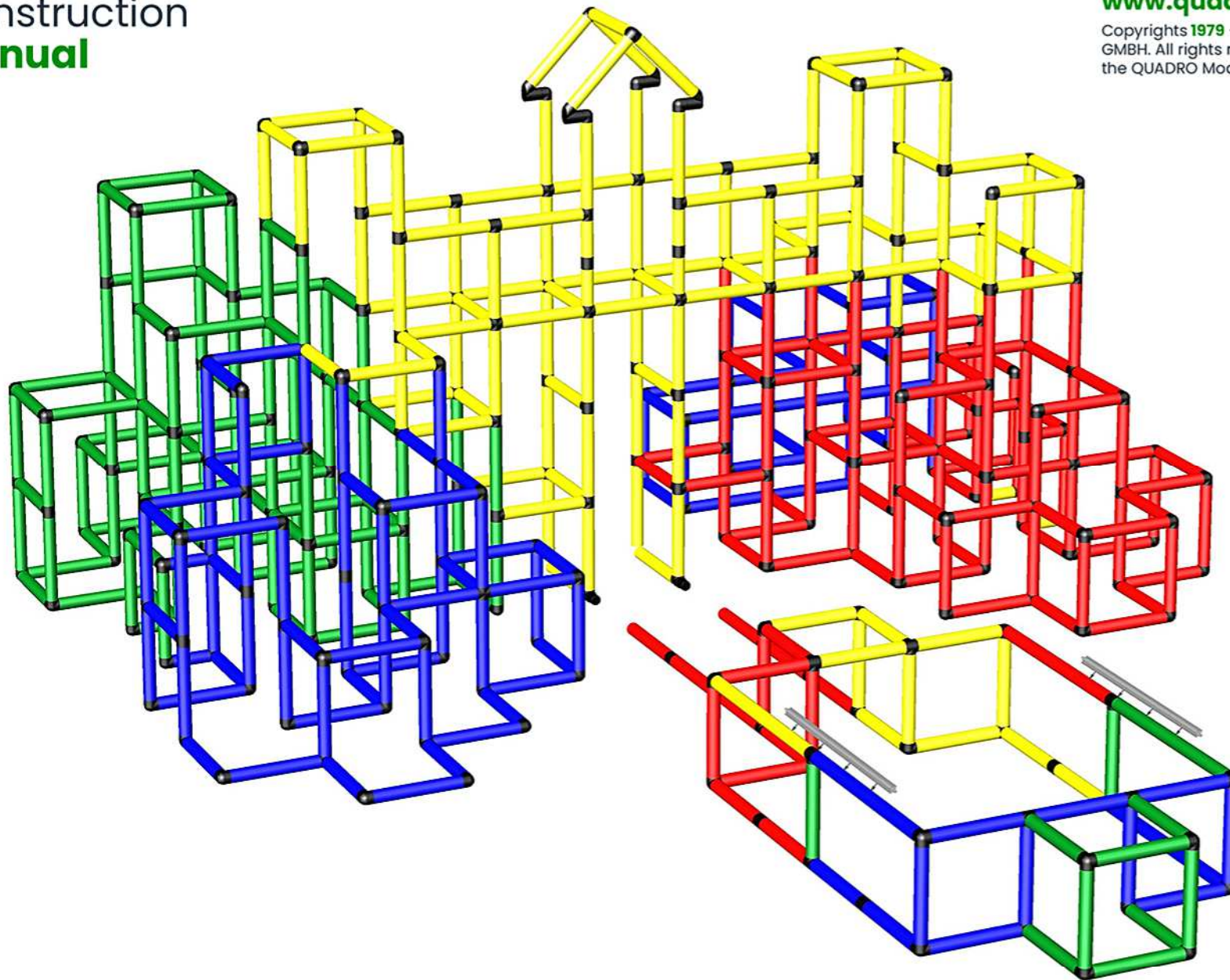

 **Caution**

Please read the **Safety Manual** carefully before you start with assembling!

C0156 *Ultra Extreme Climbing Pyramid with Bridge, Modular Slide and Pool L*
To build this model you need: 6x 31002 + 11010 + 10010 + 11670 + 90913

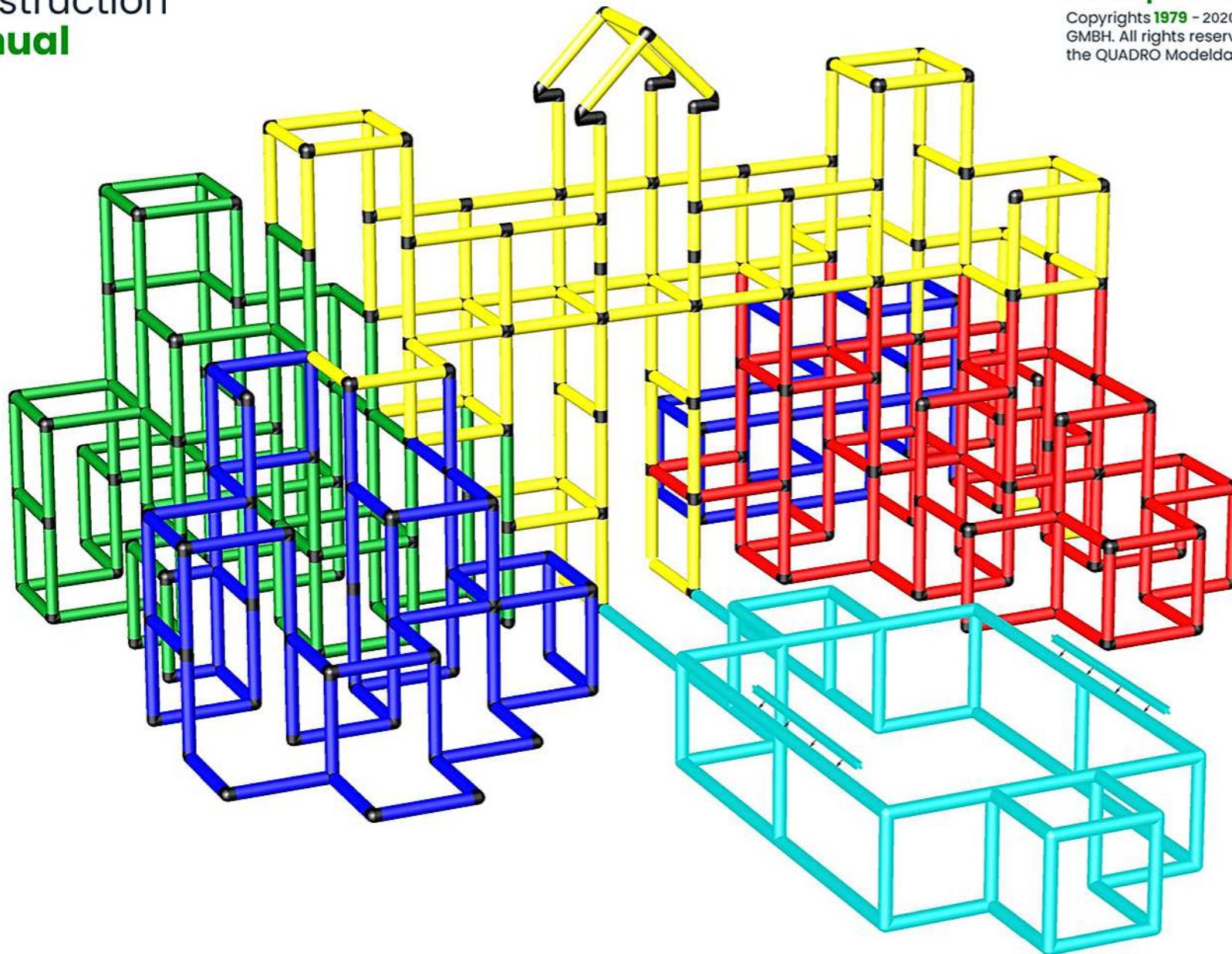

Please read the **Safety Manual** carefully before you start with assembling!

C0156 *Ultra Extreme Climbing Pyramid with Bridge, Modular Slide and Pool L*
To build this model you need: 6x 31002 + 11010 + 10010 + 11670 + 90913

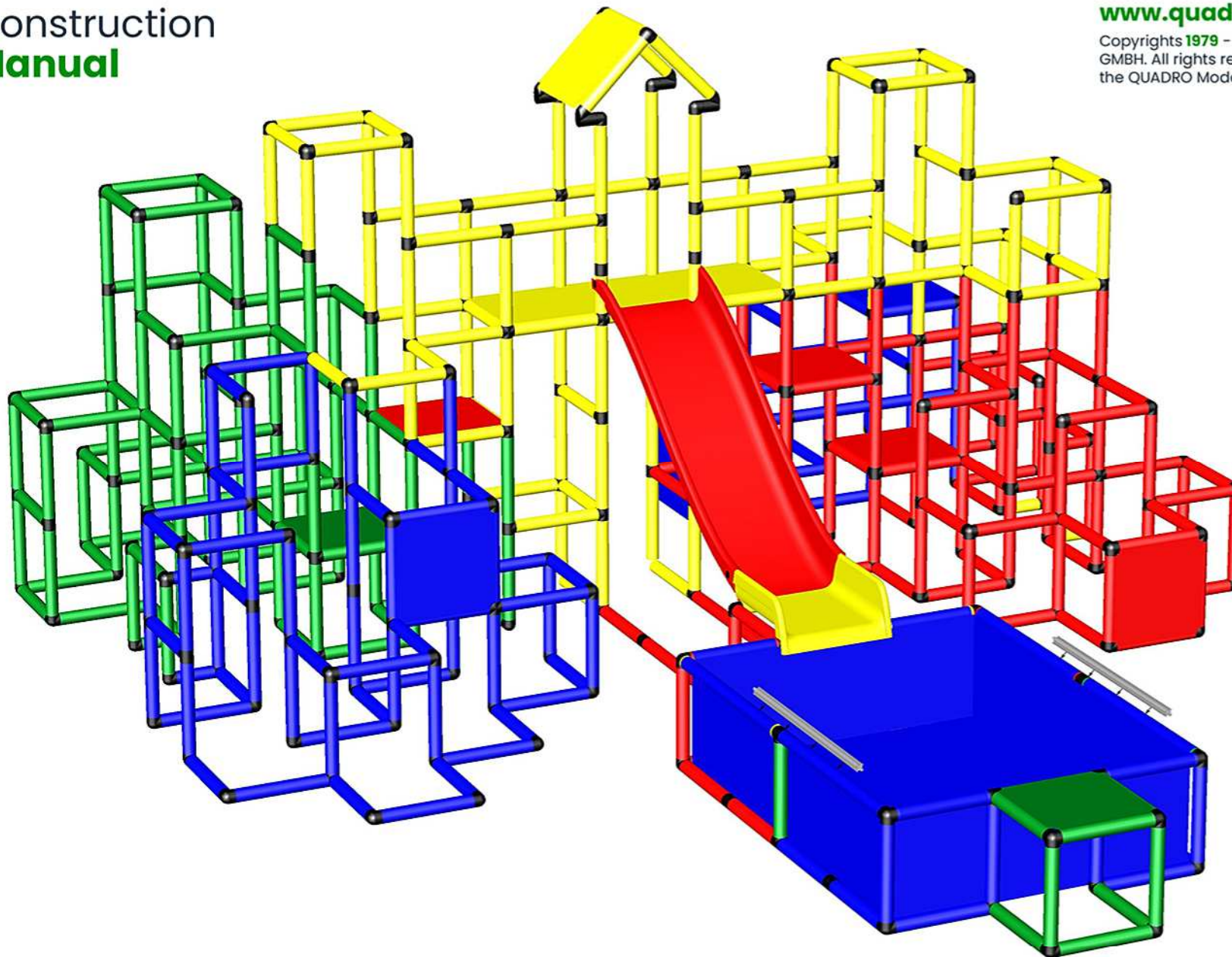

Please read the **Safety Manual** carefully before you start with assembling!

C0156 *Ultra Extreme Climbing Pyramid with Bridge, Modular Slide and Pool L*
To build this model you need: 6x 31002 + 11010 + 10010 + 11670 + 90913

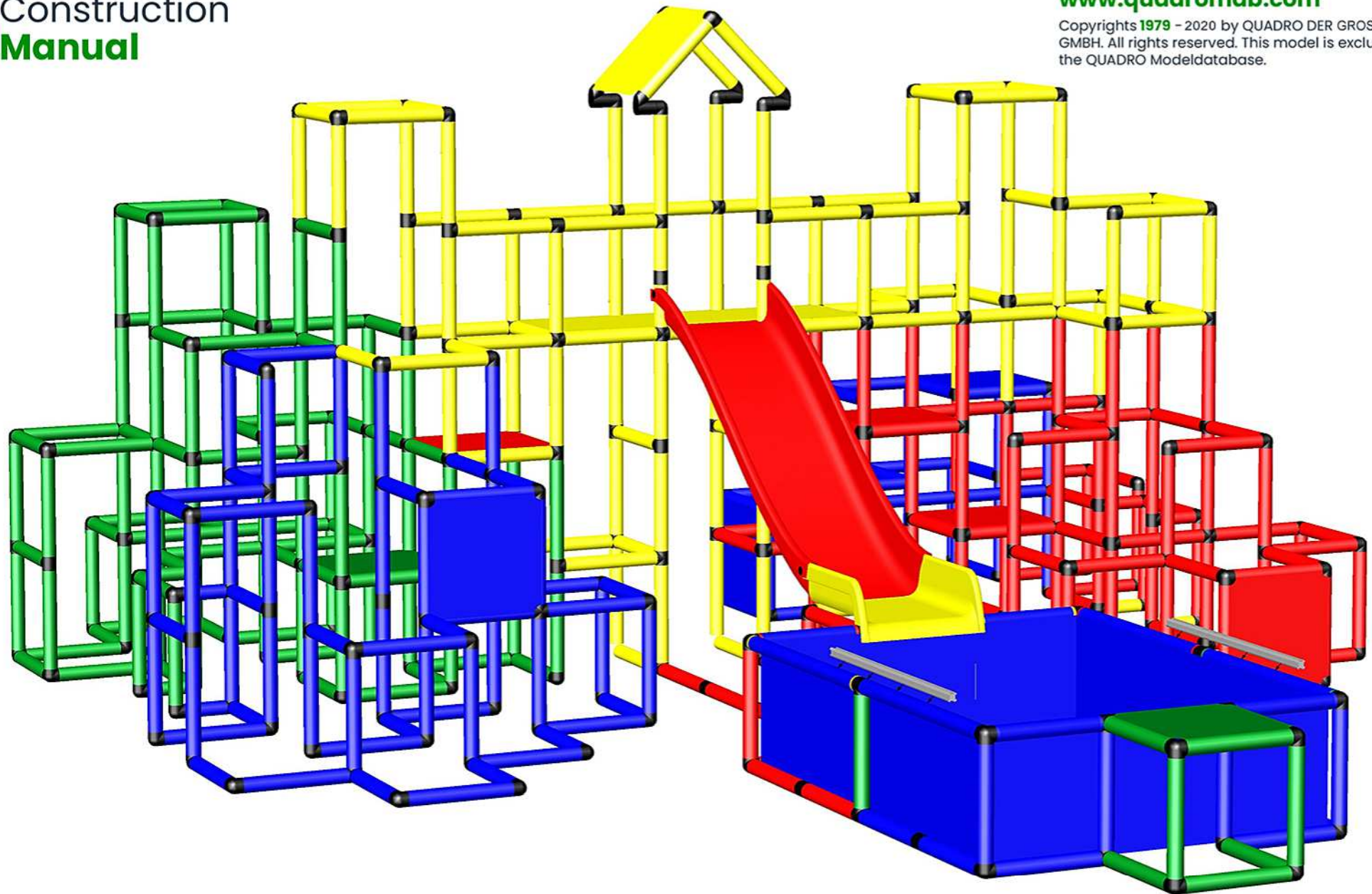

Please read the **Safety Manual** carefully before you start with assembling!

C0156 *Ultra Extreme Climbing Pyramid with Bridge, Modular Slide and Pool L*
To build this model you need: 6x 31002 + 11010 + 10010 + 11670 + 90913

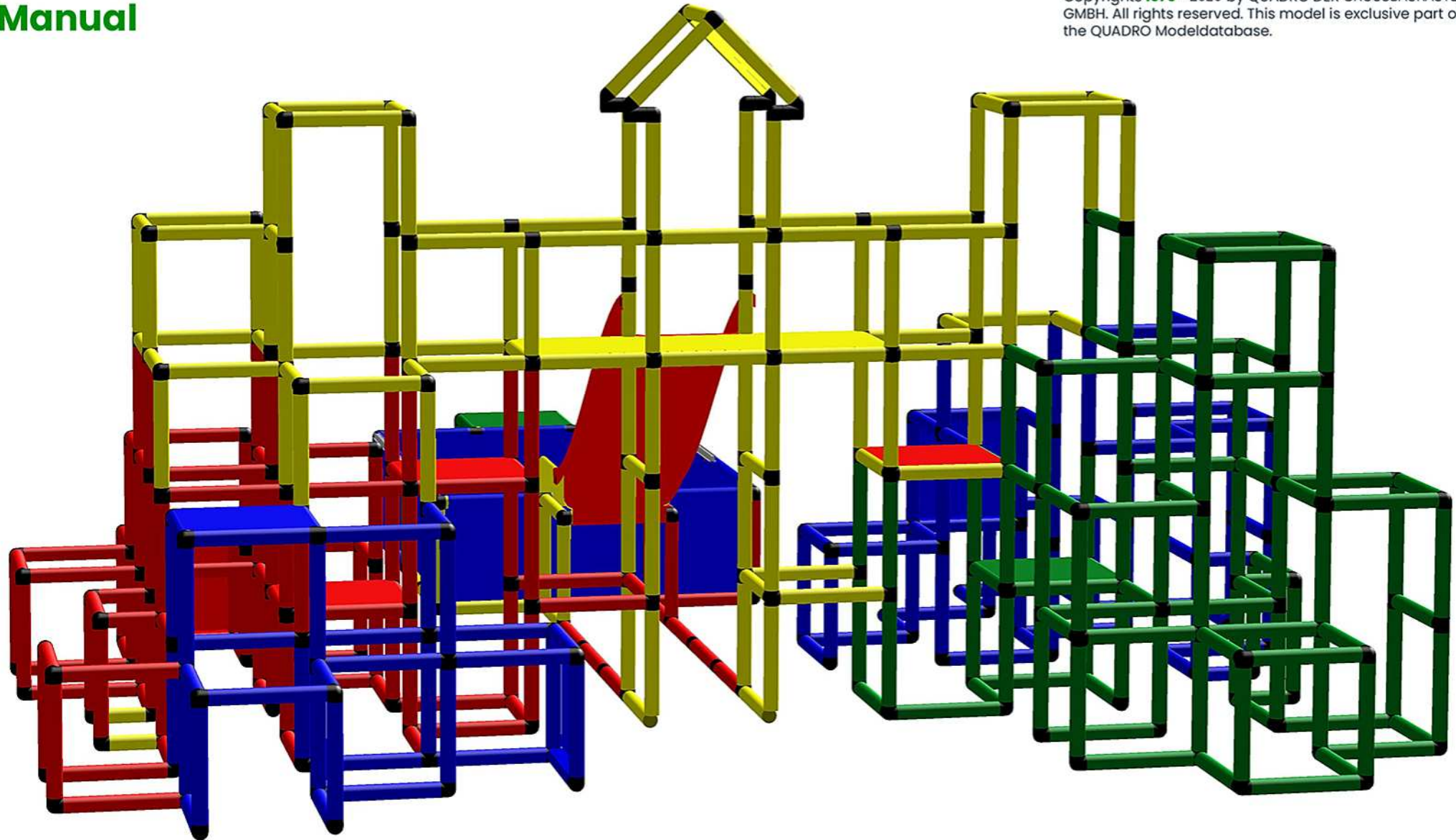

Caution

Please read the **Safety Manual** carefully before you start with
assembling!

C0156 *Ultra Extreme Climbing Pyramid with Bridge, Modular Slide and Pool L*
To build this model you need: 6x 31002 + 11010 + 10010 + 11670 + 90913